

**INDIAN INSTITUTE OF TROPICAL METEOROLOGY  
PASHAN, PUNE-411008**

**(PS/128/47/2015)**

**TENDER NOTICE**

Director, Indian Institute of Tropical Meteorology (An autonomous Institute under the Ministry of Earth Science, Govt. of India), Dr.Homi Bhabha Road, Pashan, Pune- 411 008 (India) invites sealed tenders (Part-I – Technical Bid, Part-II – Financial Bid) in separate sealed covers from Manufacturers / Suppliers and their accredited selling agents for the supply, installation, commissioning, and satisfactory demonstration of **“CCTV Equipment at Students Hostel Building of IITM – IMD, Pune” Qty – 01 Set.**

Tender documents with details can be obtained from Purchase Section of the Institute or can be download from Institute’s website.

**Pre-bid meeting** : 4<sup>th</sup> October, 2016 at 1130 hrs.  
**Last date of receipt of Tender at IITM, Pune** : 26<sup>th</sup> October 2016 at 1200 hrs.  
**Opening of Tenders (Technical bids only)** : 26<sup>th</sup> October 2016 at 1500 hrs.

The Institute reserves the right to reject any or all tenders without assigning any reason thereof. For details please visit Government’s Central Procurement Portal (CPP) <http://www.eprocure.gov.in> as well as this Institute’s Website: <http://www.tropmet.res.in>

**Scientific Officer Gr.-II, for Director  
Email :psu.iitm@tropmet.res.in**

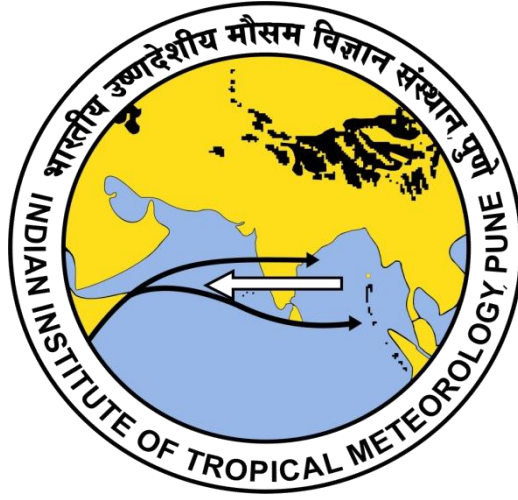

**TENDER DOCUMENT**

**FOR**

**Supply & Installation of CCTV Equipment**

---

**INDIAN INSTITUTE OF TROPICAL METEOROLOGY  
(AN AUTONOMOUS INSTITUTE OF MINISTRY OF EARTH  
SCIENCES, GOVERNMENT OF INDIA)**

**DR. HOMI BHABHA ROAD, PASHAN, PUNE 411 008  
MAHARASHTRA, INDIA**

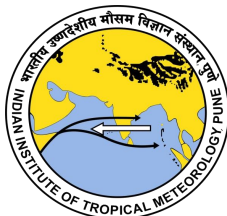

**INDIAN INSTITUTE OF TROPICAL METEOROLOGY**  
 (AN AUTONOMOUS INSTITUTE OF MINISTRY OF EARTH SCIENCES, GOVERNMENT OF INDIA)  
 DR. HOMI BHABHA ROAD, PASHAN, PUNE 411 008 MAHARASHTRA, INDIA  
 Tel #: 00 91 20 2590 4200  
 Fax #: 00 91 20 2586-5142  
 Email: psu.iitm@tropmet.res.in  
 Website: www.tropmet.res.in

**Invitation for Bids / Notice Inviting Tender**

**Date: 20-09-2016**

The Indian Institute of Tropical Meteorology (IITM), Pune an autonomous body under Ministry of Earth Sciences (MoES), Govt. of India. IITM is country's premiere research Institute to generate scientific knowledge in the field of meteorology and atmospheric sciences that has potential application in various fields such as agriculture, economics, health, water resources, transportation, communications, etc. It functions as a national centre for basic and applied research in monsoon meteorology. The Director, IITM would like to procure the following Goods / Services for its day-to-day research. The Technical specifications, Allied requirements and Scope of Supply are given in **Chapter 4** appended herewith.

Sr. No.	Tender No.	Brief Description of Goods / Services	Quantity	Single / Two Bid
<b>1</b>	<b>PS/128/47/2015</b>	<b>Supply &amp; Installation of CCTV Equipment at students hostel building of IITM – IMD, Pune</b>	<b>01 Set</b>	<b>Two</b>

**1. The address for submission of bids and for obtaining further information:**

Purchase and Stores Officer  
 Indian Institute of Tropical Meteorology,  
 Dr.Homi Bhabha Road, Pashan,  
 Pune - 411008 (India)

**2. A Pre-bid Conference will be held on schedule mentioned below. All prospective bidders are requested to kindly submit their queries to the address indicated above so as to reach the Stores & Purchase Officer at least one day before Pre-Bid Conference.**

	Date	Time in hours (IST)	Venue
<b>Pre-Bid Conference</b>	<b>04.10.2016</b>	<b>11:30 hrs.</b>	<b>Conference Hall, Near Purchase and Stores Section, IITM, Pune - 411008 Maharashtra (India)</b>

**3. The Bid prepared by the Bidder shall include the following:-**

i)	<b>Bid Security</b> a) In case of Foreign Bidder : <b>US\$ 1200</b> b) In case of Indigenous Bidder : <b>Rs.80,000.00</b>
ii)	<b>Forms as specified in Chapter No.8</b>

**4. All bids must be accompanied by a Bid Security as specified above and must be delivered to the above office before the date and time indicated below. In the event of the date specified for bid receipt is declared as a closed holiday, the due date for submission of bids will be the following working day at the appointed time.**

**5. The Schedule for Submission of Bids is as follows:-**

	Date	Time in hours (IST)	Submit to / Venue
<b>Submission of Bids</b>	<b>26<sup>th</sup> October, 2016</b>	<b>Upto 1200 hrs.</b>	<b>As detailed at Sr. No.1</b>
<b>Opening of Bids</b>	<b>26<sup>th</sup> October, 2016</b>	<b>1500 hrs</b>	

**6. The Director, The Indian Institute of Tropical Meteorology (IITM), Pune reserves the right to accept or reject any or all tenders / offers either in part or in full or to split the order without assigning any reasons there for. For details please visit Government's Central Procurement Portal (CPP) <http://www.eprocure.gov.in> as well as this Institute's Website: <http://www.tropmet.res.in>.**

## CONTENTS OF TENDER / BIDDING DOCUMENT

The bidding documents, apart from the Invitation for Bids / Notice Inviting Tender have been divided into Eight Chapters as under:

Chapter No.	Name of the Chapter	Page No.
1	Instructions to Bidder (ITB)	4
2A	General Conditions of Contract (GCC)	17
2B	Special Conditions of Contract (SCC)	29
3	Schedule of Requirements	31
4	Specifications, Allied Technical Details And Scope of Supply	32
5	Qualification requirements	41
6	Price Schedule Forms	43
7	Contract Form	45
8	Standard Forms	46

### LIST OF SHORT FORMS AND FULL FORMS

SHORT FORM	FULL FORM
BG	BANK GUARANTEE
BS	BID SECURITY
CIF	COST INSURANCE & FREIGHT
CIP	CARRIAGE PAID TO
IITM	INDIAN INSTITUTE OF TROPICAL METEOROLOGY,
CVC	CENTRAL VIGILANCE COMMISSION
DGS&D	DIRECTOR GENERAL OF SUPPLIES & DISPOSAL
EMD	EARNEST MONEY DEPOSIT
ESIC	EMPLOYEES STATE INSURANCE CORPORATION
FCA	FREE CARRIER
FOB	FREE ON BOARD
GCC	GENERAL CONDITIONS OF CONTRACT
GOI	GOVERNMENT OF INDIA
ICC	INTERNATIONAL CHAMBERS OF COMMERCE
IEMs	INDEPENDENT EXTERNAL MONITORS
IP	INTEGRITY PACT
IPC	INDIAN PENAL CODE
IST	INDIAN STANDARD TIME
IT	INCOME TAX
ITB	INSTRUCTIONS TO BIDDERS
JS (A)	JOINT SECRETARY (ADMINISTRATION)
LC	LETTER OF CREDIT
LD	LIQUIDATED DAMAGES
MAF	MANUFACTURER AUTHORISATION FORM
NIT	NOTICE INVITING TENDER
NSIC	NATIONAL SMALL INDUSTRIES CORPORATION
PS	PERFORMANCE SECURITY
SCC	SPECIAL CONDITIONS OF CONTRACT
UNCITRAL	UNITED NATIONS COMMISSION ON INTERNATIONAL TRADE LAW

**CHAPTER 1 -INSTRUCTIONS TO BIDDERS - TABLE OF CONTENTS**

<b>Clause No.</b>	<b>Contents</b>	<b>Page No.</b>
<b>A. Introduction</b>		<b>5</b>
1.1	Eligible Bidders	5
1.2	Cost of Bidding	5
1.3	Fraud and Corruption	5
<b>B. The Bidding Documents</b>		<b>5</b>
1.4	Cost of Bidding Documents	5
1.5	Content of Bidding Documents	5
1.6	Clarification of Bidding Documents	6
1.7	Amendment to Bidding Documents	6
<b>C. Preparation of Bids</b>		<b>6</b>
1.8	Language of Bid	6
1.9	Documents Comprising the Bid	7
1.10	Bid form and Price Schedule	7
1.11	Bid Prices	7
1.12	Bid Currencies	8
1.13	Documents establishing Bidder's Eligibility and Qualifications	8
1.14	Documents establishing Goods' Eligibility and Conformity to Bidding Documents	8
1.15	Bid Security / Earnest Money Deposit	9
1.16	Period of Validity of Bids	10
1.17	Format and Signing of Bid	10
<b>D. Submission and Sealing of Bids</b>		<b>11</b>
1.18	Submission, Sealing and Marking of Bids	11
1.19	Due date for Submission of Bids	11
1.20	Late Bids	12
1.21	Withdrawal, Substitution and Modification of Bids	12
<b>E. Opening and Evaluation of Bids</b>		<b>12</b>
1.22	Opening of Bids by the Purchaser	12
1.23	Confidentiality	13
1.24	Clarification of Bids	13
1.25	Preliminary Examination	13
1.26	Responsiveness of Bids	13
1.27	Non-Conformity, Error and Omission	14
1.28	Examination of Terms & Conditions, Technical Evaluation	14
1.29	Conversion of Single Currency	14
1.30	Evaluation and Comparison of Bids	14
1.31	Comparison of Bids	15
1.32	Contacting the Purchaser	15
1.33	Post qualification	15
<b>F. Award of Contract</b>		<b>16</b>
1.34	Negotiations	16
1.35	Award Criteria	16
1.36	Purchaser's right to vary Quantities at the Time of Award or later	16
1.37	Purchaser's right to accept any Bid and to reject any or all Bids	16
1.38	Notification of Award	16
1.39	Signing of Contract	16
1.40	Order Acceptance	16
1.41	Performance Security	16

## **A. Introduction**

Instructions to bidder are broad guidelines to be followed while formulating the bid and its submission to the Purchaser. It also describes the methodology for opening and evaluation of bids and consequent award of contract.

### **1.1 Eligible Bidders**

- 1.1.1. This Invitation for Bids is open to all suppliers.
- 1.1.2. Bidders should not be associated, or have been associated in the past, directly or indirectly, with a firm or any of its affiliates which have been engaged by the Purchaser to provide consulting services for the preparation of the design, specifications, and other documents to be used for the procurement of the goods to be purchased under this Invitation of Bids.
- 1.1.3. Bidders who fulfil the Eligibility Criteria mentioned in **Chapter 5** will be considered for Technical Evaluation of bids.

### **1.2 Cost of Bidding**

The Bidder shall bear all costs associated with the preparation and submission of its bid, and "the Purchaser", will in no case be responsible or liable for these costs, regardless of the conduct or outcome of the bidding process.

### **1.3 Fraud and corruption**

- 1.3.1. The purchaser requires that the bidders, suppliers and contractors observe the highest standard of ethics during the procurement and execution of such contracts. In pursuit of this policy, the following are defined:

<b>Sr. No.</b>	<b>Term</b>	<b>Meaning</b>
(a)	Corrupt practice	The offering, giving, receiving, or soliciting, directly or indirectly, of anything of value to influence the action of a public official in the procurement process or in contract execution.
(b)	Fraudulent practice	a misrepresentation or omission of facts in order to influence a procurement process or the execution of a contract.
(c)	Collusive practice	means a scheme or arrangement between two or more bidders, with or without the knowledge of the purchaser, designed to establish bid prices at artificial, non-competitive levels.
(d)	Coercive practice	means harming or threatening to harm, directly or indirectly, persons or their property to influence their participation in the procurement process or affect the execution of a contract.

- 1.3.2. The Purchaser will reject a proposal for award if it determines that the Bidder recommended for award has, directly or through an agent, engaged in corrupt, fraudulent, collusive or coercive practices in competing for the Contract in question.

## **B. The Bidding Documents**

### **1.4 Cost of Bidding Documents**

The bidding documents are to be **downloaded Free of Cost** from our Website [www.tropmet.res.in](http://www.tropmet.res.in)

### **1.5 Content of Bidding Documents**

- 1.5.1. The Goods / Services required, bidding procedures and contract terms are prescribed in the bidding documents which should be read in conjunction. The bidding documents, apart from the Invitation for Bids / Notice Inviting Tender have been divided into Eight Chapters.
- 1.5.2. The Bidder is expected to examine all instructions, forms, terms, and specifications in the bidding documents. Failure to furnish all information required by the bidding documents or submission of a bid not substantially responsive to the bidding documents in every respect will be at the Bidder's risk and may result in rejection of its bid.

## **1.6 Clarification of bidding documents**

### **1.6.1. In case when there is NO PRE-BID CONFERENCE**

A prospective Bidder requiring any clarification of the Bidding Documents shall contact the Purchaser in writing at the Purchaser's address specified in the Special Conditions of Contract (SCC). The Purchaser will respond in writing to any request for clarification, provided that such request is received not later than ten (10) days prior to the due date for submission of bids. The Purchaser shall host the response on its website, including a description of the inquiry but without identifying its source. Should the Purchaser deem it necessary to amend the Bidding Documents as a result of a clarification, it shall do so following the procedure under *Clause 1.7* relating to amendment of bidding documents and *Clause 1.19* relating to Due date for Submission of Bids. The clarifications and amendments issued would also be hosted on the website of the purchaser for the benefit of the prospective bidders who are expected to take cognizance of the same before formulating and submitting their bids.

### **1.6.2. In case when there is PRE-BID CONFERENCE**

- a) A prospective Bidder requiring any clarification of the Bidding Documents shall contact the Purchaser in writing at the Purchaser's address specified in the Special Conditions of Contract (SCC), latest by the date specified in the Invitation for Bids / NIT which would be deliberated as per **Clause 1.6.2 (b)** of Instructions to the Bidders. No request for clarification or query shall be normally entertained after the **Pre-Bid Conference**. Should the Purchaser deem it necessary to amend the Bidding Documents as a result of a clarification, it shall do so following the procedure under *Clause 1.7* relating to amendment of Bidding Documents and *Clause 1.19* relating to Due Date for Submission of Bids. The clarifications and amendments issued would also be hosted on the website of the Purchaser for the benefit of the other prospective bidders.
- b) A Pre-bid Conference shall be held as indicated in Invitation to Bid. All prospective bidders are requested to kindly attend the Pre-bid Conference. In order to facilitate IITM for proper conduct of the Pre-bid Conference, all prospective bidders are requested to kindly submit their queries (with envelope bearing Tender No. and Date on top and marked "Queries for Pre-bid Conference") so as to reach IITM as indicated in Invitation to Bid. IITM shall answer the queries during the pre-bid conference, which would become a part of the proceedings of the Pre-bid Conference. These proceedings will become a part of clarifications / amendments to the bidding documents and would become binding on all the prospective bidders. These proceedings would also be hosted on IITM website [www.tropmet.res.in](http://www.tropmet.res.in) for the benefit of all the prospective bidders. Before formulating and submitting their bids, all prospective bidders are advised to surf through the IITM website after the Pre-bid Conference, in order to enable them take cognizance of the changes made in the bidding document.

## **1.7 Amendment to Bidding Documents**

1.7.1. At any time prior to the due date for submission of bids, the Purchaser may, for any reason, whether at its own initiative or in response to a clarification requested by a prospective bidder, modify the bidding documents by amendment.

1.7.2. All prospective bidders who have down loaded the Tender Document should surf our website from time to time to know about the changes / modifications in the Tender Document. The changes / modifications would also be hosted on the website of the purchaser and all prospective bidders are expected to surf the website before formulating and submitting their bids to take cognizance of the amendments.

1.7.3. In order to allow prospective bidders reasonable time to take the amendment into account while formulating their bids, the Purchaser, at its discretion, may extend the due date for the submission of bids and host the changes on the website of the purchaser.

## **C. Preparation of bids**

### **1.8 Language of Bid**

1.8.1. The bid prepared by the Bidder, as well as all correspondence and documents relating to the bid exchanged by the Bidder and the Purchaser, shall be written in English language only especially when the details are technical. However, if GOI makes it mandatory under Rajbhasha Abhiyan, in that case views of Rajbhasha unit of IITM may be sought.

1.8.2. The Supplier shall bear all costs of translation, if any, to the English language and bear all risks of the accuracy of such translation, for documents provided by the Supplier.

**1.9 Documents Comprising the Bid**

The bid prepared by the Bidder shall include the following as per the requirement of the Tender Document:

a	Bid Security as specified in the Invitation to Bids
b	Bidder Information Form
c	Manufacturer's Authorization Form
d	Documents required to fulfil Eligibility and Qualification criteria as specified in Chapter-5
e	Detailed Technical Specifications and Scope of Supply
f	Schedule of requirements
g	Performance Statement Form
h	Service support details form
i	Deviation Statement Form
j	Bid form
k	Price Schedule Form(s)
l	Documentary evidence establishing that the bidder is eligible to bid and is qualified to perform the contract if its bid is accepted
m	Documents establishing goods eligibility and conformity to bidding documents
n	DGS&D Registration certificate in case the items under procurement falls under the restricted category of the current export-import policy of the Government of India

The documents comprising bid should be submitted in the **above sequence in orderly manner**.

**1.10 Bid form and Price Schedule**

The bidder shall complete the Bid Form and the appropriate Price Schedule form as given in Chapter- 6 furnished in the bidding documents. These forms must be completed without any alterations to its format and no substitutes shall be accepted. All blank spaces shall be filled in with the information requested. The Bid Form and the appropriate Price Schedule form shall be submitted in accordance with **ITB Clause 1.18.3** of the bidding documents.

**1.11 Bid Prices**

1.11.1. The Bidder shall indicate on the appropriate price schedule form, the unit prices and total bid prices of the Goods / Services it proposes to supply / to provide (render) under the contract.

1.11.2. Prices indicated on the price-schedule form shall be entered separately in the following manner:

(a) **For Goods manufactured within India:**

i)	The price of the goods quoted Ex-works including taxes already paid.
ii)	VAT and other taxes like excise duty etc. which will be payable on the goods if the contract is awarded.
iii)	The charges for inland transportation, insurance and other local services required for delivering the goods at the desired destination as specified in the price schedule form.
iv)	The installation, commissioning and training charges including any incidental services, if any.

(b) **For Goods manufactured abroad:**

i)	The price of the goods, quoted on FCA (named Airport abroad) or FOB (named port of shipment), as specified in the price schedule form.
ii)	The charges for insurance and transportation of the goods to the port / place of destination.
iii)	The agency commission charges payable to Indian agent in Indian rupees, if any.
iv)	The installation, commissioning and training charges including any incidental services, if any

1.11.3. The terms FOB, FCA, CIF, CIP etc shall be governed by the rules prescribed in the current edition of the Incoterms published by the International Chambers of Commerce, Paris.



- 1.11.4. Where there is no mention of packing, forwarding, freight, insurance charges, taxes etc. such offer shall be rejected as incomplete.
- 1.11.5. The price quoted shall remain fixed during the contract period and shall not vary on any account.
- 1.11.6. All lots and items must be listed and priced separately in the Price Schedules. If a Price Schedule shows items listed but not priced, their prices shall be assumed to be included in the prices of other items. Lots or items not listed in the Price Schedule shall be assumed to be not included in the bid.
- 1.11.7. The purchases made by the purchaser for scientific purpose are exempt from excise duty and Custom Duty is charged at a concessional rate, as follows:-

<b>Excise Duty</b>	The Purchaser is <b>exempted from payment of Excise duty</b> vide Govt. Of India Notification No.10/97-Central Excise dated 1 <sup>st</sup> March, 1997
<b>Custom Duty</b>	The Purchaser is <b>exempted from payment of Custom Duty</b> vide Govt. Of India Notification No.51/96-Customs dated 23 <sup>rd</sup> July, 1996

- 1.11.8. In case of imports the freight & insurance will be paid by the Purchaser, as the consignments are to be shipped through the Purchaser nominated freight forwarder **unless otherwise mentioned specifically**.
- 1.11.9. The quotation should be only in Indian Rupees for indigenous items. In case of foreign quote, the vendors may quote their rates in Indian Rupees as well as in Foreign Currency.
- 1.11.10. In case of INR bids the price criteria should be on Free Delivery to IITM, Pune. Govt. Levies like central excise duty, sales tax, etc., if any, shall be paid at actual rates applicable on the date of delivery. Rates should be quoted accordingly giving the basic price, Central Excise Duty, VAT/ Central Sales Tax etc., if any. IITM is exempted from paying Local Body Tax (LBT) & hence supplier supplying items from outside Pune Municipal limits should quote excluding LBT.
- 1.11.11. Custom Duty is levied on all import meant for IITM. Hence, the suppliers are requested to quote only on FOB/FCA basis, freight, insurance and custom duty as applicable to R&D Institutions will be paid by the Purchaser.

**Note:** All payments due under the contract shall be paid after deduction of statutory levies at source (like ESIC, IT (TDS), Service Tax, WCT etc.), wherever applicable.

**1.12 Bid Currencies**

Prices shall be quoted in Indian Rupees for offers received for supply within India and in freely Convertible foreign currency in case of offers received for supply from foreign countries.

**1.13 Documents Establishing Bidder's Eligibility and qualifications**

- 1.13.1. The bidder shall furnish, as part of its bid, documents establishing the bidders' eligibility to bid and its qualification to perform the contract if its bid is accepted.
- 1.13.2. The documentary evidence of the bidders qualification to perform the contract if the bid is accepted shall establish to the purchasers satisfaction that:

(a)	The bidder meets the qualification criteria listed in bidding documents, if any.
(b)	Bidder who doesn't manufacture the goods it offers to supply shall submit Manufacturers' Authorization Form using the form specified in the bidding document to demonstrate that it has been duly authorized by the manufacturer of the goods to quote and / or supply the goods.
(c)	In case a bidder not doing business within India, it shall furnish the certificate to the effect that the bidder is or will be represented by an agent in India, equipped and able to carry out the supply, maintenance, repair obligations etc. during the warranty and post warranty period or ensure a mechanism at place for carrying out the supply, maintenance, repair obligations etc. during the warranty and post-warranty period.

- 1.13.3. Conditional tenders / offers shall **not** be accepted.

**1.14 Documents Establishing Goods' Eligibility and Conformity to Bidding Documents**

- 1.14.1. To establish the goods' eligibility, the documentary evidence of the goods and services eligibility shall consist of a statement on the country of origin of the goods and services offered which shall be confirmed by a certificate of origin at the time of shipment.

1.14.2. To establish the conformity of the goods and services to the specifications and schedule of requirements of the bidding document, the documentary evidence of conformity of the goods and services to the bidding documents may be in the form of literature, drawings and data, and shall consist of :

(a)	A detailed description of the essential technical and performance characteristics of the goods;
(b)	A list giving full particulars, including available sources and current prices, of spare parts, special tools, etc., necessary for the proper and continuing functioning of the goods during the warranty period following commencement of the use of the goods by the Purchaser in the Price- bid ; and
(c)	An item-by-item commentary on the Purchaser's Technical Specifications demonstrating substantial responsiveness of the goods and services to those specifications or a statement of deviations and exceptions to the provisions of the Technical Specifications.

1.14.3. For purposes of the commentary to be furnished pursuant to above, the Bidder shall note that standards for workmanship, material and equipment, designated by the Purchaser in its Technical Specifications are intended to be descriptive only and not restrictive. The Bidder may substitute these in its bid, provided that it demonstrates to the Purchaser's satisfaction that the substitutions ensure substantial equivalence to those designated in the Technical Specifications.

**1.15 Bid Security (BS) / Earnest Money Deposit (EMD)**

1.15.1. The Bidder shall furnish, as part of its bid, a Bid security (BS) / Earnest Money Deposit (EMD) of amount as specified in NIT in the form of a Bank Guarantee / Demand Draft drawn on any Scheduled / Commercial / Nationalized Bank in favour of the Director, **The Indian Institute of Tropical Meteorology (IITM), Pune,**

**A. In case of Foreign Bidder(s):**

- a) The BS shall be submitted either by the principal or by the Indian agent.
- b) The bidder who submits the tender on behalf of their principals should produce documentary evidence in support of their authority to quote.
- c) The Bank Guarantee is insisted due to steep fluctuations in foreign exchange hence the foreign DDs are not accepted towards BS/EMD

**B. In the case of indigenous bidders:**

- a) The BS shall be submitted by the manufacturer or their specifically authorized dealer/bidder.

1.15.2. Bids submitted without BS/EMD will stand rejected. BS/EMD will not be accepted in the form of cash / cheque or any other form other than DD/Banker's Cheque/TDR/Bank Guarantee as per Chapter-8: **Annexure A.** No interest is payable on BS/EMD

1.15.3. The bid security is required to protect the Purchaser against the risk of Bidder's conduct, which would warrant the Bid security's forfeiture.

1.15.4. The bid security shall be in Indian Rupees for offers received for supply within India and denominated in the currency of the bid or in any freely convertible foreign exchange in the case of offers received for supplies from foreign countries in equivalent Indian Rupees. The bid security shall be in one of the following forms at the bidders' option:

(a)	A Bank Guarantee (BG) issued by a Nationalized / Scheduled bank / Commercial / Foreign Bank operating in India in the form provided in the bidding documents and valid for 45 days beyond the validity of the bid. In case a bidder desires to submit a BG issued from a foreign bank, then the same should be confirmed by a Nationalised / Scheduled Indian bank;
<b>OR</b>	
(b)	A Banker's cheque or demand draft in favour of the <b>Purchaser</b> issued by any Nationalised / Scheduled Indian bank / Commercial bank.

1.15.5. The bid security shall be payable promptly upon written demand by the purchaser in case the conditions listed in the **ITB clause 1.15.11** are invoked.

1.15.6. The bid security should be submitted in its original form. Copies shall not be accepted.

- 1.15.7. Bid security / EMD is mandatory requirement and exemption is applicable to the firms registered with NSIC only for the manufacture of the tendered goods and not for selling products manufactured by other companies.
- 1.15.8. The Bid Security of unsuccessful bidder will be discharged / returned as promptly as possible but positively within a period of 30 days after the expiration of the period of bid validity or placement of order whichever is later, without any interest.
- 1.15.9. The successful Bidder's bid security will be discharged upon the Bidder furnishing the Performance Security, without any interest. Alternatively, the BS could also be adjusted against Performance Security, if it is paid through Demand Draft / Banker's Cheque.
- 1.15.10. In case a bidder intimates at the time of tender opening in writing that the bid security is kept inside the financial bid, then in such cases, the technical bid of the party would be accepted provisionally till opening of the financial bids with which the party has attached the bid security.
- 1.15.11. The bid security may be forfeited:

(a)	If Bidder withdraws or amends or modifies or impairs or derogates its bid during the period of bid validity specified by the Bidder on the Bid Form; <b>OR</b>
(b)	In case of successful Bidder, if the Bidder fails to furnish order acceptance within <b>15</b> days of the order or fails to sign the contract and / or fails to furnish Performance Security within <b>21</b> days from the date of contract / order.

- 1.15.12. Whenever the bidder chooses to submit the Bid Security in the form of Bank Guarantee, then he should advise the banker issuing the Bank Guarantee to immediately send by Registered Post (A.D.) an unstamped duplicate copy of the Guarantee directly to the Purchaser with a covering letter to compare with the original BG for the correctness, genuineness, etc.

**1.16 Period of Validity of Bids**

- 1.16.1. Bids shall remain valid for minimum of 90 days after the date of bid opening prescribed by the Purchaser. A bid valid for a shorter period shall be rejected by the Purchaser as non-responsive.
- 1.16.2. In exceptional circumstances, the Purchaser may solicit the Bidder's consent to an extension of the period of validity. The request and the responses thereto shall be made in writing (or by fax or e-mail). The bid security provided shall also be suitably extended. A Bidder may refuse the request without forfeiting its bid security. A Bidder granting the request will not be required nor permitted to modify its bid.
- 1.16.3. Bid evaluation will be based on the bid prices without taking into consideration the above corrections.

**1.17 Format and Signing of Bid**

- 1.17.1. The bids may be submitted as Single-bid or Two-bid as specified in the Invitation for Bids / NIT.
- 1.17.2. In case the bids are invited on single bid basis, then the Bidder shall submit his / her techno-commercial offer in a single bid envelope & shall prepare two copies of the bid, clearly marking each "Original Bid" and "Copy Bid", as appropriate. In the event of any discrepancy between them, the original shall govern.
- 1.17.3. In case the bids are invited on two-bid system, the Bidder shall submit the bids in two separate parts. First part shall contain Technical bid comprising all documents listed under clause relating to Documents Comprising the Bid excepting bid form and price schedule forms. The second part shall contain the Price-Bid comprising Bid Form and Price Schedule forms. The Bidder shall prepare two copies of the bid, clearly marking each "Original Bid" and "Copy Bid", as appropriate.
- 1.17.4. The original and all copies of the bid shall be typed or written in indelible ink and shall be signed by the Bidder or a person or persons duly authorized to bind the Bidder to the Contract. All pages of the bid, except for un-amended printed literature, shall be initialled by the person or persons signing the bid.
- 1.17.5. Any interlineations, erasures or overwriting shall be valid only if they are initialled by the person or persons signing the bid.

#### **D. Submission and sealing of Bids**

##### **1.18 Submission, Sealing and Marking of Bids**

**1.18.1.** The bidders may submit their duly sealed bids generally by post or by hand.

##### **1.18.2. Sealing of Bids in the case of bids invited on Single Bid basis:**

The Bidder shall mark the Bids as "original" and "copy". The original and copy Bids shall then be sealed in an envelope.

##### **1.18.3. Sealing of Bids in the case of bids invited on Two bid basis:**

a) Technical Bid should contain documents as listed in Clause- 1.9 **without mentioning Prices** on Bid Form and Price Schedule Form(s). The Bidder shall seal the original Bid and copy Bid, duly marking the Bids as "original" and "copy". The original and copy Bids shall then be sealed in the **First Envelope** and marked as **Technical Bid**.

b) Price Bid should contain Bid Form and Price Schedule Form(s) with Rates / Prices filled in. Price Bid should be sealed in the **Second Envelop** and marked as **Price Bid**.

c) Two sealed envelopes (Technical and Price Bids) should be placed in the main envelop.

##### **1.18.4. Marking of Envelopes:**

a) The inner and outer envelopes shall be addressed to the Purchaser indicated in the Special Conditions of Contract (SCC).

b) The name and address of the bidder, Tender No., due date and a warning "Do not open before \_\_\_\_\_" to be completed with the time and date as specified in the invitation for bids.

c) All envelopes should be super scribed with

- Tender Number: \_\_\_\_\_
- Due Date\_\_\_\_\_ Time\_\_\_\_\_
- Name of the Vendor \_\_\_\_\_
- Addressed To:  
**THE DIRECTOR  
THE INDIAN INSTITUTE OF TROPICAL METEOROLOGY,  
Dr.HOMI BHABHA ROAD, PASHAN,  
PUNE-411 008 (MAHARASHTRA)- INDIA**

**1.18.5.** If the outer envelope is not sealed and marked as required above, the Purchaser will assume no responsibility for the bid's misplacement or premature opening of the submitted bid. In such cases, bids received in open condition within the due date and time will be accepted at the risk of the bidder if the same is presented to the Stores & Purchase Officer before expiry of the due date and time of opening of the bids.

**1.18.6.** Firms submitting bids in a single envelope against the requirement of two-bid system would be considered for further evaluation at the risk & responsibility of the bidder. However, the opened Price Bid would be sealed immediately by the Tender Opening Committee without disclosing the price.

##### **1.19 Due date for Submission of Bids**

**1.19.1.** Bids must be received by the Purchaser at the address specified in NIT not later than the time and date specified in NIT. In the event of the specified date for the submission of Bids being declared a holiday for the Purchaser, the Bids will be received up to the appointed time on the next working day.

**1.19.2.** The Purchaser may, at its discretion, extend the due date for submission of bids by amending the bid documents in accordance with Clause relating to Amendment of Bidding Documents in which case all rights and obligations of the Purchaser and Bidders previously subject to the due date will thereafter be subject to the due date as extended.

**1.20 Late Bids**

- 1.20.1. Any bid received by the Purchaser after the due date & time for submission of bids prescribed by the Purchaser will be rejected.
- 1.20.2. Such tenders shall be marked as late and not considered for further evaluation. They shall not be opened at all and be returned to the bidders in their original envelope without opening.

**1.21 Withdrawal, substitution and Modification of Bids**

- 1.21.1. A Bidder may withdraw, substitute, or modify its Bid after it has been submitted by sending a written notice in accordance with **ITB Clause 1.18** duly signed by an authorized representative, and shall include a copy of the authorization in accordance with **ITB Clause 1.17.4** (except that no copies of the withdrawal notice are required). The corresponding substitution or modification of the bid must accompany the respective written notice. All notices must be:

(a)	Submitted in accordance with <b>ITB Clauses 1.17 and 1.18</b> (except that withdrawal notices do not require copies), and in addition, the respective envelopes shall be clearly marked "WITHDRAWAL," "SUBSTITUTION," or "MODIFICATION"; and
(b)	Received by the Purchaser prior to the due date prescribed for submission of bids, in accordance with <b>ITB Clause 1.19</b> .

- 1.21.2. Bids requested to be withdrawn in accordance with **ITB Clause 1.21.1** shall be returned unopened to the Bidders. No bid may be withdrawn, substituted, or modified in the interval between the due date for submission of bids and the expiration of the period of bid validity specified by the Bidder on the Bid Form or any extension thereof.

**E. Opening and Evaluation of Bids**

**1.22 Opening of Bids by the Purchaser**

- 1.22.1. The Purchaser will open all bids one at a time in the presence of bidders' authorized representatives who choose to attend, as per the schedule given in Invitation for Bids. The Bidders' representatives who are present shall sign the quotation opening sheet evidencing their attendance. In the event of the specified date of Bid opening being declared a holiday for the Purchaser, the Bids shall be opened at the appointed time and location on the next working day. In case of two-bid, the Price bid shall be opened only after technical evaluation.
- 1.22.2. First, envelopes marked "WITHDRAWAL" shall be opened and read out and the envelope with the corresponding bid shall not be opened, but returned to the Bidder. No bid withdrawal shall be permitted unless the corresponding withdrawal notice contains a valid authorization to request the withdrawal and is read out at bid opening. Next, envelopes marked "SUBSTITUTION" shall be opened and read out and exchanged with the corresponding Bid being substituted, and the substituted Bid shall not be opened, but returned to the Bidder. No Bid substitution shall be permitted unless the corresponding substitution notice contains a valid authorization to request the substitution and is read out at bid opening. Envelopes marked "MODIFICATION" shall be opened and read out with the corresponding Bid. No Bid modification shall be permitted unless the corresponding modification notice contains a valid authorization to request the modification and is read out at Bid opening. Only envelopes that are opened and read out at Bid opening shall be considered further.
- 1.22.3. The bidders' names, bid modifications or withdrawals, bid prices, discounts, and the presence or absence of requisite bid security and such other details as the Purchaser, at its discretion, may consider appropriate, will be announced at the opening. No bid shall be rejected at bid opening, except for late bid(s). The contents of the bid forms and price schedule form would however be announced only at the time of opening of Price Bids in the case of two-bid system.
- 1.22.4. Bids that are received late shall not be considered further for evaluation, irrespective of the circumstances.
- 1.22.5. Bidders interested in participating in the bid opening process, should depute their representatives along with an authority letter to be submitted to the purchaser at the time of bid opening.

**1.23 Confidentiality**

- 1.23.1. Information relating to the examination, evaluation, comparison, and post qualification of bids, and recommendation of contract award, shall not be disclosed to bidders or any other persons not officially concerned with such process until Award of the Contract.
- 1.23.2. Any effort by a Bidder to influence the Purchaser in the examination, evaluation, comparison, and post qualification of the bids or contract award decisions may result in the rejection of its Bid.

**1.24 Clarification of Bids**

To assist in the examination, evaluation, comparison and post qualification of the bids, the Purchaser may, at its discretion, ask the Bidder for a clarification of its bid. The request for clarification and the response shall be in writing and no change in prices or substance of the bid shall be sought, offered or permitted. However, no negotiation shall be held except with the lowest bidder, at the discretion of the purchaser. Any clarification submitted by a bidder in respect to its bid which is not in response to a request by the purchaser shall not be considered.

**1.25 Preliminary Examination**

- 1.25.1. The Purchaser shall examine the bids to confirm that all documents and technical documentation requested in **ITB Clause 1.9** have been provided, and to determine the completeness of each document submitted.
- 1.25.2. The Purchaser shall confirm that the following documents and information have been provided in the Bid. If any of these documents or information is missing, the offer shall be rejected.

- (a) All the tenders received will first be scrutinized to see whether the tenders meet the basic requirements as incorporated in the tender enquiry document. The tenders, who do not meet the basic requirements, will be treated as non-responsive and ignored. The following are some of the important points, for which a tender may be declared as non-responsive and will be ignored, during the initial scrutiny:

i	The Bid is unsigned
ii	The Bidder is not eligible
iii	The Bid validity is shorter than the required period
iv	The Bidder has quoted for goods manufactured by a different firm without the required authority letter from the proposed manufacturer
	Bidder has not agreed to give the required performance security
vi	The goods quoted are sub-standard, not meeting the required specification, etc.
vii	Against the Requirement (Scope of supply) the bidder has not quoted for the entire requirement as specified in Chapter 4
viii	The bidder has not agreed to some essential condition(s) incorporated in the tender.

- (b) Bid Form and Price Schedule Form, in accordance with **ITB Clause 1.10**. In case of two-bid system these forms shall be examined after opening of the Price Bids of the technically qualified bidders.

**1.26 Responsiveness of Bids**

- 1.26.1. Prior to the detailed evaluation, the purchaser will determine the substantial responsiveness of each bid to the bidding documents. For purposes of this clause, a substantive responsive bid is one, which conforms to all terms and condition of the bidding documents without material deviations, reservations or omissions. A material deviation, reservation or omission is one that:

(a)	affects in any substantial way the scope, quality, or performance of the Goods and Related Services specified in the Tender; <b>OR</b>
(b)	limits in any substantial way, inconsistent with the Bidding Documents, the Purchaser's rights or the Bidder's obligations under the Proposed Contract; <b>OR</b>
(c)	if rectified, would unfairly affect the competitive position of other bidders presenting substantially responsive bids.

- 1.26.2. The Purchasers' determination of a bid's responsiveness is to be based on the contents of the bid itself without recourse to extrinsic evidence.
- 1.26.3. If a bid is not substantially responsive, it will be rejected by the Purchaser and may not subsequently be made responsive by the Bidder by correction of the material deviation, reservation or omission.

**1.27 Non-Conformity, Error and Omission**

- 1.27.1. Provided that a Bid is substantially responsive, the Purchaser may waive any non-conformities or omissions in the Bid that do not constitute a material deviation.
- 1.27.2. Provided that a bid is substantially responsive, the Purchaser may request that the Bidder submit the necessary information or documentation, within a reasonable period of time, to rectify non-material non-conformities or omissions in the bid related to documentation requirements. Such omission shall not be related to any aspect of the price of the Bid. Failure of the Bidder to comply with the request may result in the rejection of its Bid.
- 1.27.3. Provided that the Bid is substantially responsive, the Purchaser shall correct arithmetical errors on the following basis:

(a)	if there is a discrepancy between the unit price and the line item total that is obtained by multiplying the unit price by the quantity, the unit price shall prevail and the line item total shall be corrected, unless in the opinion of the Purchaser there is an obvious misplacement of the decimal point in the unit price, in which case the line item total as quoted shall govern and the unit price shall be corrected;
(b)	if there is an error in a total corresponding to the addition or subtraction of subtotals, the subtotals shall prevail and the total shall be corrected; and
(c)	if there is a discrepancy between words and figures, the amount in words shall prevail, unless the amount expressed in words is related to an arithmetic error, in which case the amount in figures shall prevail subject to (a) and (b) above.

- 1.27.4. Provided that a bid is substantially responsive, the purchaser may request that a bidder may confirm the correctness of arithmetic errors as done by the purchaser within a target date. In case, no reply is received then the bid submitted shall be ignored and its Bid Security may be forfeited.

**1.28 Examination of Terms & Conditions, Technical Evaluation**

- 1.28.1. The Purchaser shall examine the Bid to confirm that all terms and conditions specified in the GCC and the SCC have been accepted by the Bidder without any material deviation or reservation.
- 1.28.2. The Purchaser shall evaluate the technical aspects of the Bid submitted in accordance with **ITB Clause 1.14**, to confirm that all requirements specified in Chapter 4 of the Bidding Documents have been met without any material deviation or reservation.
- 1.28.3. If, after the examination of the terms and conditions and the technical evaluation, the Purchaser determines that the Bid is not substantially responsive in accordance with **ITB Clause 1.26**, it shall reject the Bid.

**1.29 Conversion to Single Currency**

To facilitate evaluation and comparison, the Purchaser will convert all bid prices expressed in the amounts in various currencies in which the bid prices are payable to Indian Rupees at the selling exchange rate established by any bank in India as notified in the Newspapers on the date of bid opening in the case of single bid and the rates prevalent on the date of opening of the Price Bids in case of two-bid. For this purpose, exchange rate notified in [www.xe.com](http://www.xe.com) or [www.rbi.org](http://www.rbi.org) or any other website would be used by the purchaser.

**1.30 Evaluation and comparison of bids**

- 1.30.1. The Purchaser shall evaluate each bid that has been determined, up to this stage of the evaluation, to be substantially responsive.
- 1.30.2. To evaluate a Bid, the Purchaser shall only use all the factors, methodologies and criteria defined below. No other criteria or methodology will be used.

1.30.3. The bids shall be evaluated on the basis of final landing cost which shall be arrived as under:

(a) **For Goods manufactured within India**

i)	The price of the goods quoted Ex-works including taxes already paid.
ii)	VAT and other taxes like excise duty etc. which will be payable on the goods if the contract is awarded.
iii)	The charges for inland transportation, insurance and other local services required for delivering the goods at the desired destination as specified in the price schedule form.
iv)	The installation, commissioning and training charges including any incidental services, if any as given in Scope of Supply (Chapter 4)

(b) **For Goods manufactured abroad**

i)	The price of the goods, quoted on FCA (named Airport abroad) or FOB (named port of shipment), as specified in the price schedule form.
ii)	The charges for insurance and transportation of the goods to the port / place of destination i.e. CIP/CIF Price.
iii)	The agency commission charges payable to Indian agent in Indian rupees, if any.
iv)	The installation, commissioning and training charges including any incidental services, if any

1.30.4. The comparison between the indigenous and the foreign offers shall be made on FOR destination basis and CIF / CIP basis respectively. However, the CIF / CIP prices quoted by any foreign bidder shall be loaded further as under:-

- (a) Towards customs duty and other statutory levies—as per applicable rates.
- (b) Towards custom clearance, inland transportation etc.- 2% of the CIF / CIP value.

**Note:** Where there is no mention of packing, forwarding, freight, insurance charges, taxes etc. such offers shall be rejected as incomplete.

1.30.5. In case of Purchase of many items against one tender, which are not inter- dependent or, where compatibility is not a problem, normally the comparison would be made on ex-works, ( in case of indigenous items) and on FOB / FCA (in the case of imports) prices quoted by the firms for identifying the lowest quoting firm for each item.

1.30.6. Orders for Imported Goods need not necessarily be on FOB / FCA basis rather it can be on the basis of any of the Incoterms latest edition as may be amended from time to time by the ICC or any other designated authority and favourable to IITM.

1.30.7. Wherever the price quoted on FOB / FCA and CIF / CIP basis are the same, the Contract would be made on CIF / CIP basis only.

1.30.8. The GCC and the SCC shall specify the mode of transport i.e. whether by air / ocean / road / rail.

**1.31 Comparison of Bids**

The Purchaser shall compare all substantially responsive bids to determine the lowest valuated bid, in accordance with **ITB Clause 1.30**.

**1.32 Contacting the Purchaser**

1.32.1. Subject to **ITB Clause 1.24**, no Bidder shall contact the Purchaser on any matter relating to its bid, from the time of the bid opening to the time the Contract is awarded.

1.32.2. Any effort by a Bidder to influence the Purchaser in its decisions on bid evaluation, bid comparison or contract award may result in rejection of the Bidder's bid.

**1.33 Post qualification**

1.33.1. In the absence of pre-qualification, the Purchaser will determine to its satisfaction whether the Bidder that is selected as having submitted the lowest evaluated responsive bid is qualified to perform the contract satisfactorily, in accordance with the criteria listed in **ITB Clause 1.13**.

1.33.2. The determination will take into account the Eligibility & Qualification criteria listed in the bidding documents and will be based upon an examination of the documentary evidence of the Bidder's qualifications submitted by the Bidder, as well as such other information as the Purchaser deems necessary and appropriate.

1.33.3. An affirmative determination will be a prerequisite for award of the contract to the Bidder. A negative determination will result in rejection of the Bidder's bid.



## **F. Award of contract**

### **1.34 Negotiations**

Normally, there shall not be any negotiation. Negotiations, if at all, shall be an exception and only in the case of items with limited source of supply. Negotiations shall be held with the lowest evaluated responsive bidder. Counter offers tantamount to negotiations, shall be treated at par with negotiations.

### **1.35 Award Criteria**

Subject to **ITB Clause 1.37**, the Purchaser will award the contract to the successful Bidder whose bid has been determined to be substantially responsive and has been determined to be the lowest evaluated bid, provided further that the Bidder is determined to be qualified to perform the contract satisfactorily. The details of the award would be hosted on the website of the Purchaser.

### **1.36 Purchaser's right to vary Quantities at Time of Award or later**

The Purchaser reserves the right at the time of Contract award to increase or decrease the quantity of goods and services originally specified in the Chapter 4 without any change in unit price or other terms and conditions. Further, at the discretion of the purchaser, the quantities in the contract may be enhanced by 30% within the delivery period.

### **1.37 Purchaser's right to accept any Bid and to reject any or all Bids**

The Purchaser reserves the right to accept or reject any bid, and to annul the bidding process and reject all bids at any time prior to award of Contract, without thereby incurring any liability to the affected Bidder or Bidders.

### **1.38 Notification of Award**

1.38.1. Prior to the expiration of the period of bid validity, the Purchaser will notify the successful bidder in writing by registered letter or by cable or telex or fax or e mail that the bid has been accepted and a separate purchase order shall follow through post.

1.38.2. Until a formal contract is prepared and executed, the notification of award should constitute a binding contract.

1.38.3. Upon the successful Bidder's furnishing of the signed Contract Form and Performance Security pursuant to **ITB Clause 1.41**, the Purchaser will promptly notify each unsuccessful Bidder and discharge its bid security.

### **1.39 Signing of Contract**

1.39.1. Promptly after notification, the Purchaser shall send the successful Bidder the Purchase Order.

1.39.2. Within twenty-one (21) days of date of the Purchase Order, the successful Bidder shall enter into Contract Agreement as per Chapter 7.

### **1.40 Order Acceptance**

1.40.1. The successful bidder should submit Order acceptance within **15** days from the date of issue of Purchase Order, failing which it shall be presumed that the vendor is not interested and his bid security is liable to be forfeited pursuant to **ITB Clause 1.15.11**.

1.40.2. The order acceptance must be received within 15 days. However, the Purchaser has the powers to extend the time frame for submission of order acceptance and submission of Performance Security (PS). Even after extension of time, if the order acceptance / PS are not received, the contract shall be cancelled and limited tenders irrespective of the value shall be invited from the responding firms after forfeiting the bid security of the defaulting firm, where applicable, provided there is no change in specifications. In such cases the defaulting firm shall not be considered again for re-tendering in the particular case.

### **1.41 Performance Security**

Within 21 days of receipt of the notification of award / Purchase Order as per the GCC Clause 2.12, the Supplier shall furnish Performance Security for the amount specified in SCC, valid for the time 60 days after the warranty period.

## CHAPTER 2

### CONDITIONS OF CONTRACT

#### A. GENERAL CONDITIONS OF CONTRACT

<b>Clause No.</b>	<b>Contents</b>	<b>Page No.</b>
2.1	Definitions	18
2.2	Contract Documents	18
2.3	Fraud and Corruption	18
2.4	Joint Venture, Consortium or Association / Amalgamation / Acquisition, Patent Indemnity	19
2.5	Scope of Supply	19
2.6	Suppliers' Responsibilities	19
2.7	Contract price	20
2.8	Copy Right	20
2.9	Application	20
2.10	Standards	20
2.11	Use of Contract Documents and Information	20
2.12	Performance Security	20
2.13	Installation, Commissioning, Demonstration, Inspection and Tests	21
2.14	Packing	21
2.15	Delivery and Documents	21
2.16	Insurance	22
2.17	Transportation	23
2.18	Incidental Services	23
2.19	Spare Parts	23
2.20	Warranty	23
2.21	Terms of Payment	25
2.22	Change Orders and Contract Amendments	25
2.23	Assignment	25
2.24	Subcontracts	25
2.25	Extension of time	25
2.26	Penalty Clause	26
2.27	Termination for Default	26
2.28	Force Majeure	26
2.29	Termination for insolvency	26
2.30	Termination for Convenience	27
2.31	Settlement of Disputes	27
2.32	Governing Language	27
2.33	Applicable Law	27
2.34	Notices	28
2.35	Taxes and Duties	28
2.36	Right to use Defective Goods	28
2.37	Protection against Damage	28
2.38	Site preparation and installation	28
2.39	Integrity Pact	28

**Note: The General Conditions of Contract shall form the part of Purchase Order / Contract.**

## **A.GENERAL CONDITIONS OF CONTRACT**

### **2.1. Definitions**

The following words and expressions shall have the meanings hereby assigned to them:

<b>Sr. No.</b>	<b>Words / Expressions</b>	<b>Meaning</b>
(a)	Contract	The Contract Agreement entered into between the Purchaser and the Supplier, together with the Contract Documents referred to therein, including all attachments, appendices, and all documents incorporated by reference therein.
(b)	Contract Documents	The documents listed in the Contract Agreement, including any amendments thereto.
(c)	Contract Price	The price payable to the Supplier as specified in the Contract Agreement, subject to such additions and adjustments thereto or deductions there from, as may be made pursuant to the Contract.
(d)	Day	Calendar day
(e)	Completion	The fulfilment of the Related Services by the Supplier in accordance with the terms and conditions set forth in the Contract.
(f)	GCC	The General Conditions of Contract.
(g)	Goods	All of the commodities, raw material, machinery and equipment, and/or other materials that the Supplier is required to supply to the Purchaser under the Contract
(h)	Services	The services incidental to the supply of the goods, such as transportation, insurance, installation, training and initial maintenance and other such obligations of the Supplier under the Contract.
(i)	SCC	The Special Conditions of Contract.
(j)	Subcontractor	Any natural person, private or government entity, or a combination of the above, to which any part of the Goods to be supplied or execution of any part of the Related Services is subcontracted by the Supplier.
(k)	Supplier	The natural Person, Private or Government entity, or a combination of the above, whose bid to perform the Contract has been accepted by the Purchaser and is named as such in the Contract Agreement.
(l)	Purchaser	The Director, The Indian Institute of Tropical Meteorology (IITM), Pune an autonomous body under Ministry of Earth Sciences (MoES), Govt. of India. as specified in SCC
(m)	The final destination	The place named in the SCC.

### **2.2 Contract Documents**

2.2.1 Subject to the order of precedence set forth in the Contract Agreement, all documents forming the Contract (and all parts thereof) are intended to be correlative, complementary, and mutually explanatory. The Contract Agreement shall be read as a whole.

2.2.2 Successful bidder shall have to enter into Contract Agreement on Rs.500/- non judicial stamp paper as per Contract Form given in Chapter 7 within 21 days of placement of Purchase Order having value above Rs. 25 lakh or equivalent amount in Foreign Currency.

### **2.3 Fraud and Corruption**

The purchaser requires that bidders, suppliers, contractors and consultants, if any, observe the highest standard of ethics during the procurement and execution of such contracts. In pursuit of this policy,

(a) The terms set forth below are defined as follows:

I	Corrupt practice	The offering, giving, receiving, or soliciting, directly or indirectly, of anything of value to influence the action of a public official in the procurement process or in contract execution
II	Fraudulent practice	A misrepresentation or omission of facts in order to influence a procurement process or the execution of a contract
III	Collusive practice	A scheme or arrangement between two or more bidders, with or without the knowledge of the Borrower, designed to establish bid prices at artificial,

		non-competitive levels
IV	Coercive practice	Harming or threatening to harm, directly or indirectly, persons or their property to influence their participation in the procurement process or affect the execution of a contract

- (b) The purchaser will reject a proposal for award if it determines that the Bidder recommended for award has, directly or through an agent, engaged in corrupt, fraudulent, collusive or coercive practices in competing for the Contract in question.

## **2.4 Joint Venture, Consortium or Association/Amalgamation/Acquisition, Patent Indemnity etc.**

If the Supplier is a joint venture, consortium, or association, all of the parties shall be jointly and severally liable to the Purchaser for the fulfilment of the provisions of the Contract and shall designate one party to act as a leader with authority to bind the joint venture, consortium, or association. The composition or the constitution of the joint venture, consortium, or association shall not be altered without the prior consent of the Purchaser.

### **2.4.1. Amalgamation/Acquisition etc.:**

In the event the Manufacturer/Supplier proposes for amalgamation, acquisition or sale its business to any firm during the contract period, the Buyer/Successor of the Principal Company are liable for execution of the contract and also fulfilment of contractual obligations i.e. supply, installation, commissioning, warranty, maintenance/replacement of spares accessories etc. You may confirm this condition while submitting the bid.

### **2.4.2 Indemnity Bond**

In order to safeguard the interest of IITM, the supplier should submit Indemnity Bond as given in Chapter-8 (Annexure-J) on Rs.500/- non judicial stamp paper within 21 days of placing of the order for Purchase Order having value above Rs. 25 lakh or equivalent amount in Foreign Currency.

### **2.4.3 Patent Indemnity**

- a) The Supplier shall, subject to the Purchaser's compliance with GCC Sub-Clause 2.4.3(a), indemnify and hold harmless the Purchaser and its employees and officers from and against any and all suits, actions or administrative proceedings, claims, demands, losses, damages, costs, and expenses of any nature, including attorney's fees and expenses, which the Purchaser may suffer as a result of any infringement or alleged infringement of any patent, utility model, registered design, trademark, copyright, or other intellectual property right registered or otherwise existing at the date of the Contract by reason of:

(I)	the installation of the Goods by the Supplier or the use of the Goods in India
<b>AND</b>	
(II)	the sale in any country of the products produced by the Goods

- b) If any proceedings are brought or any claim is made against the Purchaser, the Purchaser shall promptly give the Supplier a notice thereof and the Supplier may at its own expense and in the Purchaser's name conduct such proceedings or claim and any negotiations for the settlement of any such proceedings or claims.

## **2.5 Scope of Supply**

Scope of Supply (i.e. the Goods to be supplied and Related Services to be performed) shall be as specified in the Chapter-4 clause 4.2

## **2.6 Suppliers' Responsibilities**

The Supplier shall supply all the Goods and perform all Related Services included in the Scope of Supply-Clause 2.5 of the GCC and the Delivery & Completion Schedule, as per GCC Clause 2.15 relating to delivery and document.

## **2.7 Contract price**

Prices charged by the Supplier for the Goods supplied and the Related Services performed under the Contract shall not vary from the prices quoted by the Supplier in its bid.

**2.8 Copy Right**

The copyright in all drawings, documents, and other materials containing data and information furnished to the Purchaser by the Supplier herein shall remain vested in the Supplier, or, if they are furnished to the Purchaser directly or through the Supplier by any third party, including suppliers of materials, the copyright in such materials shall remain vested in such third party

**2.9 Application**

These General Conditions shall apply to the extent that they are not superseded by provisions in other parts of the Contract.

**2.10 Standards**

The Goods supplied and services rendered under this Contract shall conform to the standards mentioned in the Technical Specifications and Schedule of Requirements, and, when no applicable standard is mentioned, to the authoritative standard appropriate to the Goods' country of origin and such standards shall be the latest issued by the concerned institution.

**2.11 Use of Contract Documents and Information**

2.11.1 The Supplier shall not, without the Purchaser's prior written consent, disclose the Contract, or any provision thereof, or any specification, plan, drawing, pattern, sample or information furnished by or on behalf of the Purchaser in connection therewith, to any person other than a person employed by the Supplier in performance of the Contract. Disclosure to any such employed person shall be made in confidence and shall extend only so far, as may be necessary for purposes of such performance.

2.11.2 The Supplier shall not, without the Purchaser's prior written consent, make use of any document or information enumerated above except for purposes of performing the Contract.

2.11.3 Any document, other than the Contract itself, enumerated above shall remain the property of the Purchaser and shall be returned (in all copies) to the Purchaser on completion of the Supplier's performance under the Contract if so required by the Purchaser.

**2.12 Performance Security (PS)**

2.12.1 Within 21 days of receipt of the notification of award of contract / Purchase Order, the Supplier shall furnish performance security in the amount specified in SCC, valid till 60 days after the warranty period. Alternatively, the PS may also be submitted at the time of release of final payment in cases where part payment is made against delivery & part on installation. The PS, where applicable, shall be submitted in advance for orders where full payment is to be made on Letter of Credit (LC) or on delivery. In this case, submission of PS at the time of negotiation of documents through Bank would be stipulated as a condition in the LC and the BS should be kept valid till such time the PS is submitted.

2.12.2 The proceeds of the performance security shall be payable to the Purchaser as compensation for any loss resulting from the Supplier's failure to complete its obligations under the Contract.

2.12.3 The Performance Security shall be denominated in Indian Rupees for the offers received for supplies within India and denominated in the currency of the contract in the case of offers received for supply from foreign countries.

2.12.4 In the case of imports, the PS may be submitted either by the principal or by the Indian agent and, in the case of purchases from indigenous sources, the PS may be submitted by either the manufacturer or their authorized dealer / bidder.

2.12.5 The Performance security shall be in one of the following forms:

(a)	A Bank guarantee or stand-by Letter of Credit issued by a Nationalized / Scheduled bank located in India or a bank located abroad in the form provided in the bidding documents.
<b>OR</b>	
(b)	A Banker's cheque or Account Payee demand draft in favour of the purchaser.

2.12.6 The performance security will be discharged by the Purchaser and returned to the Supplier not later than 60 days following the date of completion of the Supplier's performance obligations, including any warranty obligations, unless specified otherwise in SCC, without levy of any interest.

- 2.12.7 In the event of any contract amendment, the supplier shall, within 21 days of receipt of such amendment, furnish the amendment to the performance security, rendering the same valid for the duration of the contract, as amended for further period of 60 days thereafter.
- 2.12.8 The order confirmation should be received within 15 days from the date of notification of award. However, the Purchaser has the powers to extend the time frame for submission of order confirmation and submission of Performance Security (PS). Even after extension of time, if the order acceptance and PS are not received, the contract shall be cancelled and limited tenders irrespective of the value would be invited from the responding firms after forfeiting the bid security of the defaulting firm, where applicable provided there is no change in specifications. In such cases the defaulting firm would not be considered again for re-tendering in the particular case.
- 2.12.9 Whenever, the bidder chooses to submit the Performance Security in the form of Bank Guarantee, and then he should advise the banker issuing the Bank Guarantee to immediately send by Registered Post (A.D.) an unstamped duplicate copy of the Guarantee directly to the Purchaser with a covering letter to compare with the original BG for the correctness, genuineness, etc.

### 2.13 Installation, Commissioning, Demonstration, Inspections and Tests

Bidder shall be responsible for Installation, Commissioning, Demonstration, Inspections and Tests wherever applicable and for after sales service during the warranty and thereafter as specified in Chapter 4.

### 2.14 Packing

- 2.14.1. The Supplier shall provide such packing of the Goods as is required to prevent their damage or deterioration during transit to their final destination as indicated in the Contract. The packing shall be sufficient to withstand, without limitation, rough handling during transit and exposure to extreme temperatures, salt and precipitation during transit and open storage. Packing case size and weights shall take into consideration, where appropriate, the remoteness of the Goods' final destination and the absence of heavy handling facilities at all points in transit.
- 2.14.2. The packing, marking and documentation within and outside the packages shall comply strictly with such special requirements as shall be provided for in the Contract including additional requirements, if any, specified in SCC and in any subsequent instructions ordered by the Purchaser.

### 2.15 Delivery and Documents

- 2.15.1. Delivery of the Goods and completion and related services shall be made by the Supplier in accordance with the terms specified by the Purchaser in the contract. The details of shipping and/or other documents to be furnished by the supplier are as given below or /and as specified in SCC.

<b>Details of Shipping and other Documents to be furnished by the Supplier are :</b>	
<b>A)</b>	<b>For goods manufactured or supplied from within India</b>
	Within 24 hours of dispatch, the supplier shall notify the purchaser the complete details of dispatch and also supply following documents by registered post / speed post and copies thereof by FAX/email
(a)	Three copies of Supplier's Invoice indicating, inter-alia description and specification of the goods, quantity, unit price, total value
(b)	Packing list
(c)	Certificate of country of origin
(d)	Insurance certificate, if required under the contract
(e)	Railway receipt/Consignment note
(f)	Manufacturer's warrantee certificate and in-house inspection certificate, if any
(g)	Inspection certificate issued by purchaser's inspector, if any
(h)	Any other document(s) as and when required in terms of the contract
<b>NOTE:</b>	
<b>1</b>	The nomenclature used for the item description in the invoice(s), packing list(s) and the delivery note(s) etc. should be identical to that used in the contract. The dispatch particulars including the name of the transporter should also be mentioned in the Invoice(s).
<b>2</b>	The above documents should be received by the Purchaser before arrival of the Goods and, if not received, the Supplier will be responsible for any consequent expenses.
<b>B)</b>	<b>For goods manufactured or supplied from abroad</b>
	Within 24 hours of dispatch, the supplier shall notify the purchaser the complete details of

	dispatch and also supply following documents by Registered Post / courier and copies thereof by FAX.
(a)	Three copies of supplier's Invoice giving full details of the goods including quantity, value, etc.
(b)	Packing list
(c)	Certificate of country of origin
(d)	Manufacturer's warrantee and Inspection certificate, if any
(e)	Inspection certificate issued by the Purchaser's Inspector, if any
(f)	Insurance Certificate, if required under the contract
(g)	Name of the Vessel / Carrier
(h)	Bill of Lading / Airway Bill
(i)	Port of Loading
(j)	Date of Shipment
(k)	Port of Discharge & expected date of arrival of goods
(l)	Any other document(s) as and when required in terms of the contract
<b>NOTE:</b>	
1	The nomenclature used for the item description in the invoice(s), packing list(s) and the delivery note(s) etc. should be identical to that used in the contract. The dispatch particulars including the name of the transporter should also be mentioned in the Invoice(s).
2	The above documents should be received by the Purchaser before arrival of the Goods and, if not received, the Supplier will be responsible for any consequent expenses.
	The clearing of the consignment at Mumbai Airport shall be done by our authorized Custom House Agents (CHA). The corresponding shipping documents may be forwarded to them accordingly. It is advised to give us and our CHA, a pre-alert before the consignment is dispatched. If there is delay in clearing of the consignment for <u>not</u> giving timely pre-alert then demurrage (Ware house charges), if applicable has to be refunded to us.

2.15.2. The terms FOB, FCA, CIF, CIP etc. shall be governed by the rules prescribed in the current edition of the Incoterms published by the International Chambers of Commerce (ICC), Paris.

2.15.3. The mode of transportation shall be as specified in SCC.

2.15.4. The Bidders may please note that the delivery of the system should be strictly within delivery schedule mentioned in the Chapter-4 / Purchase Order.

2.15.5. Goods should not be dispatched until the vendor receives a firm Purchase Order

## **2.16 Insurance**

2.16.1. Indigenous goods, the Goods supplied under the Contract shall be fully insured in Indian Rupees against any loss or damage incidental to manufacture or acquisition, transportation, storage and delivery in the manner specified in SCC.

2.16.2. Where delivery of the goods is required by the purchaser on CIF / CIP basis for imported goods or FOR destination for Indigenous goods, the supplier shall arrange and pay for Marine / Transit Insurance, naming the purchaser as beneficiary and initiate & pursue claims till settlement, in the event of any loss or damage.

2.16.3. Where delivery is on FOB or FCA basis for imported goods or FOR dispatch station for indigenous goods, then insurance would be the responsibility of the purchaser.

2.16.4. The equipments to be supplied will be insured by the supplier against all risks of loss or damage from the date of shipment till such time it is delivered at IITM site in case of Rupee transaction

2.16.5. With a view to ensure that claims on insurance companies, if any, are lodged in time, the Bidders and / or the Indian agent shall be responsible for follow up with their principals for ascertaining the dispatch details and informing the same to the Purchaser and he shall also liaise with the Purchaser to ascertain the arrival of the consignment after clearance so that immediately thereafter in his presence the consignment could be opened and the insurance claim be lodged, if required, without any loss of time. Any delay on the part of the Bidder / Indian Agent would be viewed seriously and he shall be directly responsible for any loss sustained by the Purchaser on the event of the delay.

## **2.17 Transportation**

- 2.17.1. Where the Supplier is required under the Contract to deliver the Goods on FOB basis, transport of the Goods, up to and including the point of putting the Goods on board the vessel at the specified port of loading, shall be arranged and paid for by the Supplier, and the cost thereof shall be included in the Contract price. Where the Supplier is required under the Contract to deliver the Goods on FCA basis, transport of the Goods and delivery into the custody of the carrier at the place named by the Purchaser or other agreed point shall be arranged and paid for by the Supplier, and the cost thereof shall be included in the Contract price.
- 2.17.2. Where the Supplier is required under the Contract to deliver the Goods CIF or CIP, transport of the Goods to the port of destination or such other named place of destination in the Purchaser's country, as shall be specified in the Contract, shall be arranged and paid for by the Supplier, and the cost thereof shall be included in the Contract Price.
- 2.17.3. In the case of supplies from within India, where the Supplier is required under the Contract to transport the Goods to a specified destination in India, defined as the Final Destination, transport to such destination, including insurance and storage, as specified in the Contract, shall be arranged by the Supplier, and the related costs shall be included in the Contract Price.
- 2.17.4. The clearing of the consignment at Mumbai Airport shall be done by our authorized Custom House Agents (CHA) for CIP / CIF consignments. The details of CHA will be given in the Purchase Order. The corresponding shipping documents may be forwarded to them accordingly. It is advised to give us and our CHA, a pre-alert before the consignment is dispatched. If there is delay in clearing of the consignment for not giving timely pre-alert then demurrage (Ware house charges), if applicable has to be refunded to us by the Supplier / Indian Agent or the same will be deducted from any payment due to Supplier / Indian Agent against this order or any other Purchase order.

## **2.18 Incidental Services**

The supplier may be required to provide any or all of the services, including training, if any, as specified in **Chapter 4: Clause-4.2**.

## **2.19 Spare Parts**

The Supplier shall be required to provide any or all of the following materials, notifications, and information pertaining to spare parts manufactured or distributed by the Supplier:

(a)	Such spare parts as the Purchaser may elect to purchase from the Supplier, providing that this election shall not relieve the Supplier of any warranty obligations under the Contract; and
(b)	In the event of termination of production of the spare parts:
	(i) Advance notification to the Purchaser of the pending termination, in sufficient time to permit the Purchaser to procure needed requirements; and
	(ii) Following such termination, furnishing at no cost to the Purchaser, the blueprints, drawings and specifications of the spare parts, if requested.

## **2.20 Warranty**

- a) The Supplier warrants that all the Goods are new, unused, and of the most recent or current models, and that they incorporate all recent improvements in design and materials, unless provided otherwise in the Contract.
- b) The Supplier further warrants that the Goods shall be free from defects arising from any act or omission of the Supplier or arising from design, materials, and workmanship, under normal use in the conditions prevailing in India.
- c) **Unless otherwise specified in the SCC**, the warranty shall remain valid for Thirty Six (36) months after the Goods, or any portion thereof as the case may be, have been delivered to and accepted at the final destination indicated in the SCC, or for Forty Two (42) months after the date of shipment from the port or place of loading in the country of origin, whichever period concludes earlier.
- d) The warranty on the associated software should cover providing of upgraded version/s, if any, released during the warranty period free of cost.



- e) The bidder shall assure the supply of spare parts after warranty is over for maintenance of the equipment supplied if and when required for a period of 10 years from the date of supply of equipment on payment on approved price list basis.
- f) The equipment must be supported by a Service Centre manned by the principal vendor's technical support engineers. The support through this Centre must be available 24 hours in a day, seven days a week and 365 days a year. Also it should be possible to contact the Principal's vendor support Centre on a toll free number/web/mail.
- g) An undertaking from the manufacturer is required in this regard stating that they would facilitate the Bidder, Service provider on regular basis with technology / product updates & extend support for the warranty as well.
- h) Supplier will have to arrange for all the testing equipment & tools required for installation, testing & maintenance etc.
- i) The Principal Supplier must have a local logistics support by maintaining a local spares depot in the country of deployment of the equipment. This is to ensure immediate delivery of spares parts from Principal Supplier of equipment to its channel partner/system integrator.
- j) Details of onsite warranty, Name of Agency that shall maintain during warranty and undertake Annual Maintenance Contract/Comprehensive Service Maintenance Contract beyond warranty shall be given in the offer. In case of foreign quote, the name of Indian Agent who shall maintain during warranty and AMC beyond warranty shall be given in the Technical Offer.
- k) The Purchaser shall give notice to the Supplier stating the nature of any such defects together with all available evidence thereof, promptly following the discovery thereof. The Purchaser shall afford all reasonable opportunity for the Supplier to inspect such defects.
- l) Upon receipt of such notice, the Supplier shall, within a reasonable period of time, expeditiously repair or replace the defective Goods or parts thereof, at no cost to the Purchaser.
- m) If having been notified, the Supplier fails to remedy the defect within a reasonable period of time; the Purchaser may proceed to take within a reasonable period such remedial action as may be necessary, at the Supplier's risk and expense and without prejudice to any other rights which the Purchaser may have against the Supplier under the Contract.
- n) In case the Equipment / System remains non-operational or performs below the desired level for more than 1 week after intimation of the fault in the Equipment / System then Warranty period shall be extended for further period for which Equipment / System remained non-operational or performed below the desired level, without prejudice to any other terms and conditions of the Contract.
- o) The defects, if any, during the warranty period are to be rectified free of charge by arranging free replacement wherever necessary.
- p) In case of any replacement during the warranty period the same shall be made free of cost i.e. DDP for import replacement and/or free delivery to IITM for indigenous replacement. All the duties / taxes relating to these replacements have to be borne by the supplier. Dispatch details of such warranty replacements have to be informed in advance to enable us to provide documents for custom clearance.
- q) Any replacements during warranty period should be free of cost. If the defective item has to be sent back to the Principal Supplier, for such replacements / returns to the Principal Supplier / Indian Agent has to bear documentation charges. If the cost of replacement is upto Rs. 5 Lakh then the documentation charges will be Rs. 5,000 and above Rs. 5 Lakh it is Rs. 10,000. Such charges have to be paid in favour of The Director, IITM, Pune. These charges are only for documentation. Any charges regarding packing, forwarding, freight, insurance, etc. should be borne by the Principal supplier / Indian Agent for returning of defective items. In other words, any warranty replacement has to be done immediately/within a week (7 days) without expecting IITM to export the defective items to Principal supplier for repair/replacements. All charges involved for re-export of defective items have to be borne by Principal supplier / Indian Agent.

**2.21 Terms of Payment**

- 2.21.1. The method and conditions of payment to be made to the Supplier under this Contract shall be as specified in the SCC.
- 2.21.2. The Supplier's request(s) for payment shall be made to the Purchaser in writing, accompanied by an invoice describing, as appropriate, the Goods delivered and the Services performed, and by documents, submitted pursuant to Delivery and document Clause of the GCC and upon fulfilment of other obligations stipulated in the contract.
- 2.21.3. Payments shall be made promptly by the Purchaser but in no case later than thirty (30) days after submission of the Invoice or claim by the Supplier.
- 2.21.4. Payment shall be made in currency as indicated in the contract.

**2.22 Change Orders and Contract Amendments**

- 2.22.1. The Purchaser may at any time, by written order given to the Supplier pursuant to Clause on Notices of the GCC make changes within the general scope of the Contract in any one or more of the following:

a)	Drawings, designs, or specifications, where Goods to be furnished under the Contract are to be specifically manufactured for the Purchaser;
b)	The method of shipping or packing;
c)	The place of delivery; and/or
d)	The Services to be provided by the Supplier.
e)	The delivery schedule.

- 2.22.2. If any such change causes an increase or decrease in the cost of, or the time required for, the Supplier's performance of any provisions under the Contract, an equitable adjustment shall be made in the Contract Price or delivery schedule, or both, and the Contract shall accordingly be amended. Any claims by the Supplier for adjustment under this clause must be ascertained within fifteen (15) days from the date of the Supplier's receipt of the Purchaser's change order.
- 2.22.3. No variation or modification in the terms of the contract shall be made except by written amendment signed by the parties.

**2.23 Assignment**

The Supplier shall not assign, in whole or in part, its obligations to perform under the Contract, except with the Purchaser's prior written consent.

**2.24 Subcontracts**

The Supplier shall notify the Purchaser in writing of all subcontracts awarded under this Contract if not already specified in the bid. Such notification, in the original bid or later, shall not relieve the Supplier from any liability or duties or obligation under the Contract.

**2.25 Extension of time**

- 2.25.1. Delivery of the Goods and performance of the Services shall be made by the Supplier in accordance with the Delivery schedule specified by the Purchaser.
- 2.25.2. If at any time during performance of the Contract, the Supplier or its sub-contractor(s) should encounter conditions impeding timely delivery of the Goods and performance of Services, the Supplier shall promptly notify the Purchaser in writing of the fact of the delay, its likely duration and its cause(s). As soon as practicable after receipt of the Supplier's notice, the Purchaser shall evaluate the situation and may, at its discretion, extend the Supplier's time for performance with or without penalty, in which case the extension shall be ratified by the parties by amendment to the Contract.
- 2.25.3. Except as provided under the Force Majeure clause of the GCC, a delay by the Supplier in the performance of its delivery obligations shall render the Supplier liable to the imposition of penalty pursuant to Penalty Clause of the GCC unless an extension of time is agreed upon pursuant to above clause without the application of penalty clause.

**2.26 Penalty clause**

Subject to GCC Clause on Force Majeure, if the Supplier fails to deliver any or all of the Goods or to perform the Services within the period(s) specified in the Contract, the Purchaser shall, without prejudice to its other remedies under the Contract, deduct from the Contract Price, as penalty, a sum equivalent to the percentage specified in SCC of the delivered price of the delayed Goods or unperformed Services or contract value for each week or part thereof of delay until actual delivery or performance, up to a maximum deduction of the Percentage specified in SCC. Once the maximum is reached, the Purchaser may consider termination of the Contract pursuant to GCC Clause on Termination for Default. The SCC shall also indicate the basis for ascertaining the value on which the penalty shall be applicable.

**2.27 Termination for Default**

2.27.1. The Purchaser may, without prejudice to any other remedy for breach of contract, by written notice of default sent to the Supplier, terminate the Contract in whole or part:

(a)	If the Supplier fails to deliver any or all of the Goods within the period(s) specified in the contract, or within any extension thereof granted by the Purchaser pursuant to GCC Clause on Extension of Time;
(b)	If the Supplier fails to perform any other obligation(s) under the Contract
(c)	If the Supplier, in the judgment of the Purchaser has engaged in corrupt or fraudulent or collusive or coercive practices as defined in GCC Clause on Fraud or Corruption in competing for or in executing the Contract.

2.27.2. In the event the purchaser terminates the contract in whole or in part, he may take recourse to any one or more of the following action:

(a)	The Performance Security/EMD will be forfeited;
(b)	The Purchaser may procure, upon such terms and in such manner as it deems appropriate, Goods similar to those undelivered, and the supplier shall be liable for all available actions against it in terms of the contract.
(c)	However, the supplier shall continue to perform the contract to the extent not terminated.

**2.28 Force Majeure**

2.28.1. Notwithstanding the provisions of GCC Clauses relating to Extension of Time, Penalty and Termination for Default the Supplier shall not be liable for forfeiture of its Performance Security, Liquidated Damages or Termination for Default, if and to the extent that, its delay in performance or other failure to perform its obligations under the Contract is the result of an event of Force Majeure.

2.28.2. For purposes of this Clause, "Force Majeure" means an event or situation beyond the control of the Supplier that is not foreseeable, is unavoidable, and its origin is not due to negligence or lack of care on the part of the Supplier. Such events may include, but not be limited to, acts of the Purchaser in its sovereign capacity, wars or revolutions, fires, floods, epidemics, quarantine restrictions, and freight embargoes.

2.28.3. If a Force Majeure situation arises, the Supplier shall promptly notify the Purchaser in writing of such conditions and the cause thereof within 21 days of its occurrence. Unless otherwise directed by the Purchaser in writing, the Supplier shall continue to perform its obligations under the Contract as far as is reasonably practical, and shall seek all reasonable alternative means for performance not prevented by the Force Majeure event.

2.28.4. If the performance in whole or in part or any obligations under the contract is prevented or delayed by any reason of Force Majeure for a period exceeding 60 days, either party may at its option terminate the contract without any financial repercussions on either side.

**2.29 Termination for Insolvency**

The Purchaser may at any time terminate the Contract by giving written notice to the Supplier, if the Supplier becomes bankrupt or otherwise insolvent. In this event, termination will be without compensation to the Supplier, provided that such termination will not prejudice or affect any right of action or remedy, which has accrued or will accrue thereafter to the Purchaser.

**2.30 Termination for Convenience**

- 2.30.1. The Purchaser, by written notice sent to the Supplier, may terminate the Contract, in whole or in part, at any time. The notice of termination shall specify that termination is for the Purchaser's convenience, the extent to which performance of the Supplier under the Contract is terminated, and the date upon which such termination becomes effective.
- 2.30.2. The Goods that are complete and ready for shipment within 30 days after the Supplier's receipt of notice of termination shall be accepted by the Purchaser at the Contract terms and prices. For the remaining Goods, the Purchaser may elect:

(a)	To have any portion completed and delivered at the Contract terms and prices ; <b>and / or</b>
(b)	To cancel the remainder and pay to the Supplier an agreed amount for partially completed Goods / Services and for materials and parts previously procured by the Supplier.

**2.31 Settlement of Disputes**

- 2.31.1. The Purchaser and the supplier shall make every effort to resolve amicably by direct informal negotiation any disagreement or dispute arising between them under or in connection with the Contract.
- 2.31.2. If, after twenty-one (21) days, the parties have failed to resolve their dispute or difference by such mutual consultation, then either the Purchaser or the Supplier may give notice to the other party of its intention to commence arbitration, as hereinafter provided, as to the matter in dispute, and no arbitration in respect of this matter may be commenced unless such notice is given. Any dispute or difference in respect of which a notice of intention to commence arbitration has been given in accordance with this Clause shall be finally settled by arbitration. Arbitration may be commenced prior to or after delivery of the Goods under the Contract. .
- 2.31.3. The dispute settlement mechanism / arbitration proceedings shall be concluded as under:

(a)	In case of Dispute or difference arising between the Purchaser and a domestic supplier relating to any matter arising out of or connected with this agreement, such disputes or difference shall be settled in accordance with the Indian Arbitration & Conciliation Act, 1996, the rules there under and any statutory modifications or re-enactments thereof shall apply to the arbitration proceedings. The dispute shall be referred to the Director <b>The Indian Institute of Tropical Meteorology (IITM), Pune</b> and if he is unable or unwilling to act, to the sole arbitration of some other person appointed by him willing to act as such Arbitrator. The award of the arbitrator so appointed shall be final, conclusive and binding on all parties to the Contract.
(b)	In the case of a dispute between the purchaser and a Foreign Supplier, the dispute shall be settled by arbitration In accordance with provision of sub-clause (a) above. But if this is not acceptable to the supplier then the dispute shall be settled in accordance with provisions of UNCITRAL (United Nations Commission on International Trade Law) Arbitration Rules.

- 2.31.4. The venue of the arbitration shall be the place from where the Purchase Order or Contract is issued.
- 2.31.5. Notwithstanding any reference to arbitration herein,

(a)	the parties shall continue to perform their respective obligations under the Contract unless they otherwise agree; <b>and</b>
(b)	the Purchaser shall pay the Supplier any monies due the Supplier.

**2.32 Governing Language**

The Contract shall be written in English language which shall govern its interpretation. All correspondence and other documents pertaining to the Contract, which are exchanged by the parties, shall be written in the English language only.

### **2.33 Applicable Law / Jurisdiction**

The Contract shall be interpreted in accordance with the laws of the Union of India and all disputes shall be subject to place of jurisdiction as specified in SCC.

### **2.34 Notices**

- 2.34.1. Any notice given by one party to the other pursuant to this contract / order shall be sent to the other party in writing or by cable, telex, FAX, e-mail or / and confirmed in writing to the other party's address specified in the SCC.
- 2.34.2. A notice shall be effective when delivered or on the notice's effective date, whichever is later.

### **2.35 Taxes and Duties**

- 2.35.1. For goods manufactured outside India, the Supplier shall be entirely responsible for all taxes, stamp duties, license fees, and other such levies imposed outside India.
- 2.35.2. For goods Manufactured within India, the Supplier shall be entirely responsible for all taxes, duties, license fees, etc., incurred till its final manufacture / production.
- 2.35.3. If any tax exemptions, reductions, allowances or privileges may be available to the Supplier in India, the Purchaser shall make its best efforts to enable the Supplier to benefit from any such tax savings to the maximum allowable extent.
- 2.35.4. All payments due under the contract shall be paid after deduction of statutory levies (at source) (like ESIC, IT, etc.) wherever applicable.
- 2.35.5. IITM is exempted from paying LBT & hence supplier supplying from outside Pune Municipal limits should quote prices excluding LBT.

### **2.36 Right to use Defective Goods**

If after delivery, installation and within commissioning & acceptance and within warranty period, the operation or use of the goods proves to be unsatisfactory, the Purchaser shall have the right to continue to operate or use such goods until rectifications of defects, errors or omissions by repair or by partial or complete replacement is made without interfering with the Purchaser's operation.

### **2.37 Protection against Damage**

The system shall not be prone to damage during power failures and trip outs. The normal voltage and frequency conditions available at site as under:

- (a) Voltage 230 volts – Single phase or 415 Volt for 3 phase ( $\pm 10\%$ )
- (b) Frequency 50 Hz.

### **2.38 Site preparation and installation**

The Purchaser is solely responsible for the construction of the equipment sites unless otherwise specified in Chapter 4 in compliance with the technical and environmental specifications defined by the Supplier. The Purchaser will designate the installation sites before the scheduled installation date to allow the Supplier to perform a site inspection to verify the appropriateness of the sites before the installation of the Equipment, if required. The supplier shall inform the purchaser about the site preparation, if any, needed for installation, of the goods at the purchaser's site immediately after notification of award / contract.

### **2.39 Integrity Pact**

- 2.39.1. As per directive of the CVC all organizations including IITM have to adopt an Integrity pact (IP) to ensure transparency, equity and competitiveness in major Public procurement having procurement value above Rs.5 Crore. The integrity pact envisages an agreement between the prospective bidders / vendors with the buyer committing the persons / officials of both the parties with the aim not to exercise any corrupt influence on any aspect of the contract. Only those bidders / vendors, who are willing to enter in to such an integrity pact with the Purchaser, would be competent to participate in the bidding.
- 2.39.2. IP also envisages Panel of Independent External Monitors (IEMs) which shall be provided / recommended by MoES and institutes with the approval of by CVC.

- 2.39.3. The integrity Pact would be effective from the date of invitation of bids till complete execution of the contract.
- 2.39.4. **The SCC shall specify whether there is a need to enter into a separate integrity pact or not.** If the Integrity Pact is required for the Tender then the format of Integrity Pact is as given in **Chapter – 8**.

**CHAPTER 2**

**B. SPECIAL CONDITIONS OF CONTRACT (SCC)**

The following Special Conditions of Contract (SCC) shall supplement and / or amend the General Conditions of Contract (GCC). Whenever there is a conflict, the provisions herein shall prevail over those in the GCC.

GCC Clause	Special Condition of Contract (SCC)
GCC 2.1.1(m)	<b>The Purchaser is:</b> THE DIRECTOR INDIAN INSTITUTE OF TROPICAL METEOROLOGY Dr.HOMI BHABHA ROAD, PASHAN, PUNE-411 008 (MAHARASHTRA)- INDIA
GCC 2.1.1(n)	<b>The Final Destination is:</b> INDIAN INSTITUTE OF TROPICAL METEOROLOGY Dr.HOMI BHABHA ROAD, PASHAN, PUNE-411 008 (MAHARASHTRA)- INDIA
GCC 2.12.1	The amount of the <b>Performance Security</b> shall be <b>10 % of the contract value</b> , valid up to 60 days after the date of completion of contract obligations including warranty obligations.
GCC 2.14.2	<b>The marking and documentation</b> within and outside the packages shall be marked with proper paint / indelible ink.
	(a) Each package should have a packing list within it detailing the Part No.(s), description, quantity etc.
	(b) Outside each package, the Contract No., the name and address of the Purchaser and the Final destination should be indicated on all sides and top.
	(c) Each package should be marked as 1/x, 2/x, 3/x.....x/x, where “x” is the total No. of packages contained in the consignment.
	(d) All the sides and top of each package should carry an appropriate indication / label / stickers indicating the precautions to be taken while handling / storage.
GCC 2.15.3	(a) In case of supplies from within India, the <b>mode of transportation</b> shall be by <b>Air / Rail / Road</b> .
	(b) In case of supplies from abroad, the <b>mode of transportation</b> shall be by <b>Air/Sea</b> .
GCC 2.16.1	The <b>Insurance</b> shall be for an amount equal to <b>110% of the CIF or CIP</b> value of the contract from “warehouse to warehouse (final destination)” on “all risk basis” including strikes, riots and civil commotion, in addition to <b>storage policy for 60 days</b> is advised so as to ensure the inspection by the Indian Agent at the time of opening the packages.
GCC 2.20 (c)	The period of validity of the Warranty shall be:  The warranty shall remain valid for <b>Thirty Six (36)</b> months after the Goods, or any portion thereof as the case may be, have been delivered to and accepted at the final destination or for <b>Forty Two (42)</b> months after the date of shipment from the port or place of loading in the country of origin, whichever period concludes earlier.
GCC 2.21.1	<b>The method and conditions of payment</b> to be made to the Supplier under this Contract shall be as follows:
	<b>A</b> <b>Payment for Goods supplied from abroad:</b>
	Payment of foreign currency portion shall be made in currency of the Contract in the following manner:
	(a) On Shipment: <b>Eighty (80%)</b> percent of the Contract Price of the Goods shipped shall be paid through irrevocable letter of credit opened in favour of the Supplier in a bank in its country, upon submission of documents specified in GCC Clause 2.15.
	(b) On Acceptance: <b>Twenty (20%)</b> percent of the Contract Price of Goods received shall be paid within thirty (30) days of receipt of the Goods and successful installation & commissioning upon submission of claim supported by the acceptance certificate issued by the Purchaser along with the <b>Performance security</b> , if any.
	(c) The LC for 100% value of the contract shall be established after deducting the agency commission payable if any, to the Indian agent from the FOB / FCA value.

	(d)	The LC will be confirmed at the suppliers cost, if requested specifically by the supplier. All bank charges abroad shall be to the account of the beneficiary i.e. supplier and all bank charges in India shall be to the account of the opener i.e. purchaser. If LC is requested to be extended/ reinstated for reasons not attributable to the purchaser, the charges thereof would be to the suppliers' account. Payment of local currency portion shall be made in Indian Rupees within thirty (30) days of presentation of claim supported by a certificate from the Purchaser declaring that the Goods have been delivered and that all other contracted Services have been performed.
	<b>B</b>	<b>Payment for Goods and Services supplied from India:</b>
		The payment shall be made in Indian Rupees, as follows:
	(a)	On shipment : <b>Eighty (80%)</b> percent of the Contract Price shall be paid on receipt of the Goods and upon submission of the documents specified in <b>GCC Clause 2.15</b>
	(b)	On Acceptance: The remaining <b>Twenty (20%)</b> percent of the Contract value shall be paid to the Supplier within thirty (30) days after the date of the acceptance certificate issued by the Purchaser subject to submission of performance security, if any.
	(c)	In case of supplies where installation & commissioning is not required payment will be made within 30 days from receipt of items by purchaser as per purchase order contract.
	(d)	<b>E-Payment:</b> All payments, IITM prefers to make Electronic Transfers (RTGS) / (NEFT)
		<b>NOTE:</b>
	➤	All payments due under the Contract shall be paid after deduction of statutory levies at source (like ESIC, Income Tax, etc.), wherever applicable.
GCC 2.26.1	(a)	As time is the essence of the contract, Delivery period mentioned in the Purchase Order should be strictly adhered to. Otherwise we will have to forfeit EMD/PS and also LD clause will be applicable /enforced
	(b)	If the supplier fails to Supply, Install and Commission the system as per specifications mentioned in the order within the due date, the Supplier is liable to pay liquidated damages of 1% of order value per week of delay subject to a maximum of 10% beyond the due date. Such money will be deducted from any amount due or which may become due to the supplier
	(c)	IITM reserves the right to cancel the order in case the delay is more than 10 weeks. Penalties, if any, will be deducted from the EMD/PS
	(d)	The <b>maximum</b> amount of <b>penalty</b> shall be <b>10%</b> .
	(e)	<b>The liquidated damages shall be levied on the delivered price of the delayed Goods or unperformed Services or contract value.</b>
GCC 2.33.1		The <b>place of jurisdiction</b> is <b>Pune, India.</b>
GCC 2.34.1		<b>For notices, the Purchaser's address is</b>  THE DIRECTOR INDIAN INSTITUTE OF TROPICAL METEOROLOGY Dr.HOMI BHABHA ROAD, PASHAN, PUNE-411 008 (MAHARASHTRA)- INDIA <b>Telephone # : 0091-20-25904200</b> <b>Facsimile number : 0091-20- 2586-5142</b> <b>E-mail address: <a href="mailto:psu.iitm@tropmet.res.in">psu.iitm@tropmet.res.in</a></b>
GCC 2.39.4		<b>The Integrity pact is <u>not to be signed.</u></b> However, efforts must be made to realize the objectives & spirits thereof.



### CHAPTER 3

(To be filled by the bidder and enclosed with the Technical Bid)

#### SCHEDULE OF REQUIREMENT

The Schedule of Requirement must clearly specify **the time frame required (Schedule) for delivery of goods and services to be completed** by the bidder (in reference to Scope of Supply given in Clause-4.2 of Chapter-4) if the Contract is awarded for the offer / proposal submitted by the bidder in response to this Tender.

**A) Delivery Schedule:**

Sr. No.	Brief Description of Goods and Services	Quantity & Unit	Delivery Schedule

Period of delivery shall start from : \_\_\_\_\_

**B) Term of delivery / Delivery Term :**

Goods from Abroad	
Goods from India	

**C) Time frame required for conducting installation, commissioning of the equipment, acceptance test, training, etc. after the arrival of consignment or before dispatch of equipment:**

Sr. No.	Activity	Time Frame
1	Site Preparation (if required)	
2	Installation & Commissioning	
3	Acceptance Test	
4	Training	
5		

Place : \_\_\_\_\_

Signature of the Bidder : \_\_\_\_\_

Date : \_\_\_\_\_

## **CHAPTER 4**

### **SPECIFICATIONS AND ALLIED TECHNICAL DETAILS**

#### **4.1 Specifications of CCTV Equipment at students hostel building of IITM-IMD Qty - 01 Set.**

##### **Technical Requirements and Specifications**

**(Please refer Appendix No. – 1, available on page no. 55 to 79 of tender documents)**

- Note: 1) Optional items mentioned in the quotation will not be considered for commercial evaluation  
2) Items to be supplied from India should be quoted in Indian Currency only

#### **4.2 Scope of Supply**

**Scope of Supply includes the following:**

- (i) Supply of the equipment / system as specified in 4.1 above
- (ii) Installation & Commissioning
- (iii) Training as specified below in 4.4
- (iv) On site comprehensive Warranty as specified in 4.5 (i) below
- (v) Supply of Spare parts as specified in 4.1 above

#### **4.3 Inspection & Tests**

##### **4.3.1 General**

- (i) The Supplier shall at its own expense and at no cost to the Purchaser carry out all such tests and/or inspections of the Goods and Related Services as are specified here. The Supplier shall at its own expense and at no cost to the IITM carry out all such tests and/or inspections of the Goods and Related Services as are specified in the chapter 4 or as discussed and agreed to during the course of finalization of contract.
- (ii) The inspections and tests may be conducted on the premises of the Supplier or its subcontractor(s), at the point of delivery and/or at the Goods final destination. If conducted on the premises of the Supplier or its subcontractor(s), all reasonable facilities and assistance, including access to drawings and production data - shall be furnished to the inspectors at no charge to the IITM
- (iii) Whenever the Supplier is ready to carry out any such test and inspection, it shall give a reasonable advance notice, including the place and time, to the Purchaser. The Supplier shall obtain from any relevant third party or manufacturer any necessary permission or consent to enable the Purchaser or its designated representative to attend the test and/or inspection.
- (iv) The IITM or its representative shall have the right to inspect and/or to test the Goods to confirm their conformity to the Contract specifications at no extra cost to the IITM and what inspections and tests the IITM requires and where they are to be conducted. The IITM shall notify the Supplier in writing in a timely manner of the identity of any representatives retained for these purposes.
- (v) Should any inspected or tested Goods fail to conform to the specifications, the purchaser may reject the goods and the Supplier shall either replace the rejected Goods or make alterations necessary to meet specification requirements free of cost to the Purchaser.
- (vi) The Purchaser's right to inspect, test and, where necessary, reject the Goods after the Goods' arrival at final destination shall in no way be limited or waived by reason of the Goods having

previously been inspected, tested and passed by the Purchaser or its representative prior to the Goods shipment.

- (vii) The Supplier shall provide the Purchaser with a report of the results of any such test and/or inspection.
- (viii) With a view to ensure that claims on insurance companies, if any, are lodged in time, the bidders and /or the Indian agent, if any, shall be responsible for follow up with their Principals for ascertaining the dispatch details and informing the same to the Purchaser and he shall also liaise with the Purchaser to ascertain the arrival of the consignment after customs clearance so that immediately thereafter in his presence the consignment could be opened and the insurance claim be lodged, if required, without any loss of time. Any delay on the part of the bidder/ Indian Agent would be viewed seriously and he shall be directly responsible for any loss sustained by the purchaser on the event of the delay.
- (ix) Before the goods and equipment are taken over by the Purchaser, the Supplier shall supply operation and maintenance Manuals together with Drawings of the goods and equipment built. These shall be in such details as will enable the Purchase to operate, maintain, adjust and repair all parts of the works as stated in the specifications.
- (x) The Manuals and Drawings shall be in the ruling language (English) and in such form and numbers as stated in the Contract.
- (xi) Unless and otherwise agreed, the goods and equipment shall not be considered to be completed for the purposes of taking over until such Manuals and Drawing have been supplied to the Purchaser.
- (xii) On successful completion of acceptability test, receipt of deliverables, etc and after the Purchaser is satisfied with the working of the equipment, the acceptance certificate signed by the Supplier and the representative of the Purchaser will be issued. The date on which such certificate is signed shall be deemed to be the date of successful commissioning of the equipment. Acceptance certificate form as given in Annexure-I (Chapter 8) should be signed by authorised representative of Supplier & Purchaser.
- (xiii) Installation demonstration is to be arranged by the supplier and the same is to be done within 15 days of the arrival of the equipment at site.

#### **4.3.2 Manufacturer's Inspection Certificate**

After the goods are manufactured and assembled, inspection and testing of the goods shall be carried out at the supplier's plant by the supplier, prior to shipment to check whether the goods are in conformity with the technical specifications. Manufacturer's test certificate with data sheet shall be issued to this effect and submitted along with the delivery documents. The purchaser reserves the options to be present at the supplier's premises during such Pre-dispatch inspection and testing.

#### **4.3.3 Installation, Commissioning & Acceptance Test**

The acceptance test will be conducted by the Purchaser, their consultant or other such person nominated by the Purchaser at its option after the equipment is installed at Purchaser's site in the presence of supplier's representatives. The acceptance will involve trouble free operation. There shall not be any additional charges for carrying out acceptance test. No malfunction, partial or complete failure of any part of the equipment is expected to occur. The Supplier shall maintain necessary log in respect of the result of the test to establish to the entire satisfaction of the Purchaser, the successful completion of the test specified.

In the event of the ordered item failing to pass the acceptance test, a period not exceeding two weeks will be given to rectify the defects and clear the acceptance test, failing which, the Purchaser reserve the right to get the equipment replaced by the Supplier at no extra cost to the Purchaser.

Successful conduct and conclusion of the acceptance test for the installed goods and equipment shall also be the responsibility and at the cost of the Supplier.

#### 4.4 Training

- |                           |   |
|---------------------------|---|
| (i) Location:             | IITM  |
| (ii) Number of persons:   | For a group of students / technical staff   |
| (iii) Period of Training: | 5 working days after installation   |
| (iv) Nature of training:  | To operate the equipment efficiently, training to collection & processing of the data, structure solution & refinement, safe handling of the equipment and minimum maintenance. |

#### 4.5 Incidental Services

##### (i) On site Comprehensive Warranty:

- The system excluding X-ray source and detector should be warranted for a period of 3 years (comprehensive warranty) from the date of installation whereas the warranty for the X-ray source and detector should be for a period of 5 years.
- Down-time call attendance should be within 24 hrs.
- In case the Equipment / System remains non-operational for more than 7 days then warranty period will be extended for the equivalent period for which Equipment / System remained non-operational. Warranty extension in such case shall be done without prejudice to any other Term & condition of the contract

##### (ii) Annual Maintenance Contract (AMC):

- Non-Comprehensive AMC for Five years after expiry of warranty may be quoted separately.

#### 4.6 Delivery Schedule

4-6 weeks After Receipt of Order

#### 4.7 Commercial evaluation of bid

The bid will be treated as **Incomplete** if bidder has **not quoted** for all the components given in scope of supply (clause 4.2) and **the incomplete bid will be rejected**. The bidder should also quote for all incidental services (clause 4.5). The bid will be commercially evaluated for the components in the scope of supply.

## CHAPTER 5

### Qualification Requirements

The Bidder shall furnish documentary evidence along with Technical Bid to support the following Qualification Criteria:

- 1) The bidder shall furnish documentary evidence to demonstrate that the bidder satisfies the bidders' **eligibility criteria**, as mentioned in **ITB Clause 1.1.2** in the form as per **Annexure-K of Chapter- 8**.
- 2) **Financial Qualifying Criteria:**  
The Bidder shall furnish documentary evidence to meet the following Financial Qualifying Criteria:
  - a) An **undertaking (self-certificate)** is to be submitted that the Organization has not been blacklisted during last 3 years by any Central / State Government Department/Organization in the form as per **Annexure-L of Chapter- 8**.
  - b) The Creditworthy report - **MIRA inform report** of the **OEM / Principal** supplier for the Current Financial Year is to be enclosed along with the Technical Bid **if the total price of the Equipment/System is more than Rs. 1 crore (Rs.10 million)**. The minimum rating for Financial Qualification is **Rating-Ba**.

The Creditworthy Report may be obtained from:

M/s. MIRA INFORM PRIVATE LIMITED,  
605, Palmspring, Near D'Mart,  
Link Road, Malad (West),  
Mumbai: 400 064;  
Tel Nos.: 022 – 40448000 (44 lines)  
Fax No. 022-0448045 / 40448046;  
E-mail: [mira@mirainform.com](mailto:mira@mirainform.com); [info@mirainform.com](mailto:info@mirainform.com)  
Website: <http://www.mirainform.com>

Note: The creditworthy report from other reputed and equivalent firms (such as Dun & Bradstreet) is also acceptable. However, report should have been obtained after **1<sup>st</sup> April 2015**.

- 3) The Bidder should be a manufacturer /authorized representative of a manufacturer who must have designed, manufactured, tested and supplied the equipment(s) similar to the type specified in the "Technical Specification". The **Manufacturers' Authorization Form** Chapter-8: Annexure B must be enclosed with the technical bid.
- 4) **Experience and Technical Capacity:**  
The Bidder shall furnish documentary evidence to demonstrate that it meets the following experience requirement(s):
  - a) Equipment / System offered must be of the most recent series/models incorporating the latest improvements in design. The models should be in successful operation for at least one year as on date of Bid Opening.
  - b) The bidder (OEM/Direct Distributor/Dealer) should have supplied and installed during **past 3 years, at least two similar equipments / systems** as mentioned in Chapter-4. The Bidder should furnish the information on all past supplies and satisfactory performance during past 3 years in the **Performance Statement Form** (Chapter-8, Annexure D). Bidders shall invariably furnish documentary evidence (Client's certificate) in support of the **satisfactory operation of the equipment / system**.
  - c) Details of Service Centres and information on service support facilities that would be provided after the warranty period (in the **Service Support Form- Chapter-8 Annexure-F**).

- d) That adequate and specialized expertise is already available **or** will be made available following the execution of the contract in the Purchaser's country, to ensure that **the support services are responsive and adequate** as per **ITB 1.13.2(c)**.
- 5) The Indian Agents of foreign manufacturers/ suppliers quoting directly on behalf of their principals for items appearing in the **restricted list of the current EXIM policy of the Govt. of India** must be registered with DGS&D.
- 6) Either the Indian Agent on behalf of the foreign principal or the foreign principal directly could bid in a tender **but not both**. However, the offer of the Indian Agent should also accompany the authorization letter from their principal. Further, to maintain sanctity of tendering system **one Indian agent cannot represent two different foreign principals in one tender**.

**The bidders who do not fulfil the above Eligibility, Financial and Technical Qualification Criteria shall be rejected during the Evaluation of Technical Bid.**

**CHAPTER 6- A:PRICE SCHEDULE FOR GOODS BEING OFFERED FROM ABROAD**

*(Bidder should quote in this format however, if quoted in different format; all parameters given below should be covered)*

Tender No: \_\_\_\_\_ Tender Date: \_\_\_\_\_  
 Quotation No. \_\_\_\_\_ Date: \_\_\_\_\_ Quotation Valid Upto: \_\_\_\_\_

Country of Origin: _____			Currency: _____			
Sr.No.	Description of Item		Quantity	Unit	Rate	Amount
	Catalogue, Part/Model No.	Specifications				
1.	Item name					
2.	Required Spares/Consumables (if any)					
3.	Accessories (if any)					
4.	Additional Items					
Total Ex-Works Price						
(-) LESS: Discount ___% (if any)						
Net Ex-Works Price						
(+ ) Packing & Forwarding Charges						
(+ ) Inland Freight Charges						
(INCO TERM): FOB / FCA _____International Airport, _____ Country						
(+ ) Freight upto Mumbai & Insurance Charges						
CIF / CIP MUMBAI Price						
Approximate Weight of the Consignment			Approximate Dimensions of the Consignment			

TENDER CLAUSE NO.	TERM		CONDITION	
GCC/SCC 2.15.3	Mode of Shipment		BY AIR / SEA / ROAD	
GCC 2.15.2	Delivery Term(INCOTERM)			
CHAPTER 3	Delivery Schedule		As enclosed in Technical Bid as per Chapter-3	
	Period of delivery shall count from			
	Time Frame required for conducting Installation & commissioning of the equipment, Acceptance Test, Training, etc.			
	Port of destination		Mumbai,India	
	Final Destination		IITM, Pune	
	Installation & Commissioning Charges			
4.4	Training Details & Charges			
GCC/SCC 2.20 (c)	Warranty		Period	Charges if any
	Annual Maintenance Contract	Comprehensive		
		Non-Comprehensive		
GCC/SCC 2.21.1	Payment Term			
GCC/SCC 2.21.1 (d)	Bank Charges		Inside India to IITM account and Outside India to beneficiary's account	

**SIGNATURE OF AUTHORISED PERSON**

**CHAPTER 6- B :PRICE SCHEDULE FOR GOODS BEING OFFERED FROM INDIA**

*(Bidder should quote In this format however, if quoted In different format; all parameters given below should be covered)*

Tender No: \_\_\_\_\_ Tender Date: \_\_\_\_\_  
 Quotation No. \_\_\_\_\_ Date: \_\_\_\_\_ Quotation Valid Upto: \_\_\_\_\_

Sr.No.	Description of Item		Quantity	Unit	Rate	Amount (Rs.)
	Catalogue, Part/Model No.	Specifications				
1.	Item name					
2.	Required Spares/Consumables (if any)					
3.	Accessories (if any)					
4.	Additional Items					
Total Ex-Works Price						
(-) LESS: Discount ___% (if any)						
Net Ex-Works Price						
Excise Duty: Exempted against Notification No.10/97 applicable to IITM						
(+ ) Packing & Forwarding Charges						
(+ ) Transportation Charges						
(IITM is <b>not</b> exempted for VAT / CST) VAT / CST Charges						
SUB TOTAL						
Local Body Tax: ITM is exempted vide PMC Reg.No. LBT-005-0064836 for supplies from outside Pune Municipal Corporation Limits						
GRAND TOTAL						
Approximate Weight of the Consignment			Approximate Dimensions of the Consignment			

TENDER CLAUSE NO.	TERM		CONDITION	
GCC/SCC 2.15.3	Mode of Shipment		BY AIR / RAIL / ROAD	
GCC 2.15.2	Delivery Term		Free Delivery to IITM Pune	
CHAPTER 3	Delivery Schedule		As enclosed in Technical Bid as per Chapter-3	
	Period of delivery shall count from			
	Time Frame required for conducting Installation & commissioning of the equipment, Acceptance Test, Training, etc.			
	Port of destination		Mumbai, India	
	Final Destination		IITM, Pune	
	Installation & Commissioning Charges including taxes			
4.4	Training Details & Charges			
GCC/SCC 2.20.3	Warranty		Period	Charges if any
	Annual Maintenance Contract	Comprehensive		
		Non-Comprehensive		
GCC/SCC 2.21.1	Payment Term			

**SIGNATURE OF AUTHORISED PERSON**



**CHAPTER 7**

**Contract Form**

Contract No. \_\_\_\_\_ Date: \_\_\_\_\_

THIS CONTRACT AGREEMENT is made  
the [ *insert: number* ] day of [ *insert: month* ], [ *insert: year* ].

**BETWEEN**

- (1) Indian Institute of Tropical Meteorology registered under the Societies Registration Act 1860 of the Government of India having its registered office at Dr. Homi Bhabha Road, Pashan, Pune - 411 008, India (hereinafter called "the Purchaser"), and
- (2) [ *Insert name of Supplier* ], a corporation incorporated under the laws of [ *Insert: country of Supplier* ] and having its principal place of business at [ *insert: address of Supplier* ] (hereinafter called "the Supplier").

WHEREAS the Purchaser invited bids for certain Goods and ancillary services, viz., [ *Insert brief description of Goods and Services* ] and has accepted a Bid by the Supplier for the supply of those Goods and Services in the sum of [ *Insert Contract Price in words and figures, expressed in the Contract currency(ies)* ] (hereinafter called "the Contract Price").

**NOW THIS AGREEMENT WITNESSETH AS FOLLOWS:**

- 01. In this Agreement words and expressions shall have the same meanings as are respectively assigned to them in the Conditions of Contract referred to.
- 02. The following documents shall constitute the Contract between the Purchaser and the Supplier, and each shall be read and construed as an integral part of the Contract:

(a)	This Contract Agreement
(b)	General Conditions of Contract
(c)	Special Conditions of Contract
(d)	Technical Requirements (including Schedule of Requirements and Technical Specifications)
(e)	The Supplier's Bid and original Price Schedules
(f)	The Purchaser's Notification of Award
(g)	[ <i>Add here any other document(s)</i> ]

- 03. This Contract shall prevail over all other Contract documents. In the event of any discrepancy or inconsistency within the Contract documents, then the documents shall prevail in the order listed above.
- 04. In consideration of the payments to be made by the Purchaser to the Supplier as hereinafter mentioned, the Supplier hereby covenants with the Purchaser to provide the Goods and Services and to remedy defects therein in conformity in all respects with the provisions of the Contract.
- 05. The Purchaser hereby covenants to pay the Supplier in consideration of the provision of the Goods and Services and the remedying of defects therein, the Contract Price or such other sum as may become payable under the provisions of the Contract at the times and in the manner prescribed by the Contract.

IN WITNESS whereof the parties hereto have caused this Agreement to be executed in accordance with the laws of Union of India on the day, month and year indicated above.

For and on behalf of the Council of Scientific & Industrial Research

Signed : [ *Insert signature* ]  
in the capacity of [ *insert title or other appropriate designation* ]  
in the presence of [ *insert identification of official witness* ]

Signed : [ *Insert signature* ]  
in the capacity of [ *insert title or other appropriate designation* ]  
in the presence of [ *insert identification of official witness* ]

For and on behalf of the Supplier

Signed : [ *Insert signature of authorized representative(s) of the Supplier* ]  
in the capacity of [ *insert title or other appropriate designation* ]  
in the presence of [ *insert identification of official witness* ]

**CHAPTER 8**  
**OTHER STANDARD FORMS**

<b>Sr. No.</b>	<b>Name of the Form</b>	<b>Annexure</b>
1	Bidder Information Form	A
2	Manufacturers' Authorization Form	B
3	Bid Security Form / Earnest Money Deposit	C
4	Performance Statement Form	D
5	Deviation Statement Form	E
6	Service Support Detail Form	F
7	Bid Form	G
8	Performance Security Form	H
9	Acceptance Certificate Form	I
10	Indemnity Bond	J
11	Eligibility Certificate	K
12	Non Black List Certificate	L

**NOTE: The Successful Bidder shall submit Documents with reference to Annexure – H, I & J after Award of Contract as mentioned in Purchase Order.**

**Bidder Information Form**

- (a) [The Bidder shall fill in this Form in accordance with the instructions indicated below. No alterations to its format shall be permitted and no substitutions shall be accepted. This should be done of the letter head of the firm]

Date : [Insert date (as day, month and year) of Bid Submission]

Tender No : [Insert number from Invitation for bids]

01.	Bidder's Legal Name [Insert Bidder's legal name]
02.	In case of JV, legal name of each party: [Insert legal name of each party in JV]
03.	Bidder's actual or intended Country of Registration: [Insert actual or Intended Country of Registration]
04.	Bidder's Year of Registration: [Insert Bidder's year of registration]
05.	Bidder's Legal Address in Country of Registration: [Insert Bidder's legal address in country of registration]
06.	<p>Bidder's Authorized Representative Information</p> <p>Name: [Insert Authorized Representative's name]</p> <p>Address: [Insert Authorized Representative's Address]</p> <p>Telephone/Fax numbers: [Insert Authorized Representative's telephone/fax numbers]</p> <p>Email Address: [Insert Authorized Representative's email address]</p>
07.	<p>Attached are copies of original documents of:</p> <p>Articles of Incorporation or Registration of firm named in 1, above.</p>

Signature of Bidder \_\_\_\_\_

Name \_\_\_\_\_

Business Address \_\_\_\_\_

**MANUFACTURERS' AUTHORIZATION FORM**

***[The Bidder shall require the Manufacturer to fill in this Form in accordance with the instructions indicated. This letter of authorization should be on the letterhead of the Manufacturer and should be signed by a person with the proper authority to sign documents that are binding on the Manufacturer.]***

Date : *[Insert date (as day, month and year) of Bid Submission]*

Tender No. : *[Insert number from Invitation For Bids]*

To : *[Insert complete name and address of Purchaser]*

**WHEREAS**

We *[insert complete name of Manufacturer]*, who are official manufacturers of *[insert type of goods manufactured]*, having factories at *[insert full address of Manufacturer's factories]*, do hereby authorize *[insert complete name of Bidder]* to submit a bid the purpose of which is to provide the following Goods, manufactured by us *[insert name and or brief description of the Goods]*, and to subsequently negotiate and sign the Contract.

We hereby extend our full guarantee and warranty in accordance with Clause 2.20 of the General Conditions of Contract, with respect to the Goods offered by the above firm.

Signed: *[insert signature(s) of authorized representative(s) of the Manufacturer]*

Name: *[insert complete name(s) of authorized representative(s) of the Manufacturer]*

Title: *[insert title]*

Duly authorized to sign this Authorization on behalf of: *[insert complete name of Bidder]*

Dated on \_\_\_\_\_ day of \_\_\_\_\_, \_\_\_\_\_ *[insert date of signing]*

**BID SECURITY FORM**

Whereas \_\_\_\_\_  
(hereinafter called the tenderer)

has submitted their offer dated \_\_\_\_\_  
for the supply of \_\_\_\_\_  
(hereinafter called the tender)

Against the Purchaser's Tender No. \_\_\_\_\_  
KNOW ALL MEN by these presents that WE \_\_\_\_\_  
of \_\_\_\_\_ having our registered office at  
\_\_\_\_\_ are bound unto \_\_\_\_\_ (hereinafter called the "Purchaser")

In \_\_\_\_\_ the \_\_\_\_\_ sum \_\_\_\_\_ of \_\_\_\_\_

For which payment will and truly to be made to the said Purchaser, the Bank binds itself, its successors and assigns by these presents. Sealed with the Common Seal of the said Bank this \_\_\_\_\_ day of \_\_\_\_\_ 20\_\_\_\_.

**THE CONDITIONS OF THIS OBLIGATION ARE:**

(1)	If the tenderer withdraws or amends or modifies or impairs or derogates from the Tender in any respect within the period of validity of this tender.
(2)	If the tenderer having been notified of the acceptance of his tender by the Purchaser during the period of its validity
(3)	If the tenderer fails to furnish the Performance Security for the due _____ Performance of the contract.
(4)	Fails or refuses to accept/execute the contract.

We undertake to pay the Purchaser up to the above amount upon receipt of its first written demand, without the Purchaser having to substantiate its demand, provided that in its demand the Purchaser will note that the amount claimed by it is due to it owing to the occurrence of one or both the two conditions, specifying the occurred condition or conditions.

This guarantee will remain in force up to and including 45 days after the period of tender validity and any demand in respect thereof should reach the Bank not later than the above date.

\_\_\_\_\_  
(Signature of the authorized officer of the Bank)

Name and designation of the officer  
Seal, name & address of the Bank and address of the

Branch

**Note:** Whenever the bidder chooses to submit the Bid Security in the form of Bank Guarantee, then he should advise the banker issuing the Bank Guarantee to immediately send by Registered Post (A.D.) an unstamped duplicate copy of the Guarantee directly to the Purchaser with a covering letter to compare with the original BG for the correctness, genuineness, etc.

**PERFORMANCE STATEMENT FORM**

**Details of similar equipment / systems supplied & installed during past 3 years in India & Abroad**

**Name of the Firm** \_\_\_\_\_

Order Placed by (full address of Purchaser)	Order No. and date	Description and quantity of ordered equipment	Value of order	Date of completion of deliver as per contract	Date of actual completion of delivery	Remarks indicating reasons for late delivery, if any	Has the equipment been installed/ working satisfactory? (Attach a certificate from the purchaser / Consignee)	Name of Contact person along with Telephone No., FAX No. and e-mail address

Signature and Seal of the manufacturer/Bidder .....

Place :

Date :

**DEVIATION STATEMENT FORM**

**PART -I**

**The following are the particulars of deviations from the requirements of the tender specifications:**

<b>CLAUSE</b>	<b>DEVIATION</b>	<b>REMARKS (INCLUDING JUSTIFICATION)</b>

**Place:**

**Date:**

**Signature and seal of the  
Manufacturer/Bidder**

**NOTE:**

**Where there is no deviation, the statement should be returned duly signed with an endorsement indicating "No Deviations".**

**PART – II**  
**(Refer Clause 1.25 of Tender Document)**

Sr.No.	TENDER REQUIREMENT	COMPLIANCE	Document Submitted
1	Bid is Signed	Yes / No	Yes / NA
2	This is to certify that we are eligible to bid for this tender as per clause No.1.1 (As per Chapter 8 Annexure-K)	Yes / No	Yes / NA
3	Bid Validity (90 days after the date of Bid opening)	Yes / No Bid valid up to	Yes / NA
4	Warranty: As per Clause 4.5 (i) of Chapter-4- from Installation & Commissioning and date of acceptance	Yes / No	Yes / NA
5	Agree to submit Performance Security 10% of PO Value as per Clause 2.12.1	Yes / No	Yes / NA
6	Bidder Information Form enclosed as per Chapter 8: Annexure –A	Yes / No	Yes / NA
7	Manufacturers Authorisation Form (MAF) (If Applicable) Chapter 8, Annexure-B	Yes / No	Yes / NA
8	Certification of non-black listing (Self Certification) as specified in Chapter 5, (Sr.No.3 )& (Chapter 8 Annexure-K)	Yes / No	Yes / NA
9	Performance Statement Form enclosed as per Annexure D of Chapter 8 with reference to Chapter 5 - 4(a) & 4(b)	Yes / No	Yes / NA
10	Service Support details enclosed as per Annexure F of Chapter 8 with reference to Chapter 5 - 4(c) & 4(d)	Yes / No	Yes / NA

The Bidder should **submit other documents** such as fulfilment of financial qualification criteria (MIRA Inform Report), Schedule of Requirement (Chapter-3) and various forms as specified in Chapter-8.



**SERVICE SUPPORT DETAIL FORM**

<b>Sr. No.</b>	<b>List of similar type of equipments serviced in the past 3 years</b>	<b>Address, Telephone Nos., Fax No. and e-mail address of the buyer</b>	<b>Nature of training Imparted/ service provided</b>	<b>Name and address of service provider</b>

Signature and Seal of the manufacturer/Bidder.....

Place :

Date :

**Bid Form**

*[The Bidder shall fill in this Form in accordance with the instructions indicated No alterations to its format shall be permitted and no substitutions shall be accepted.]*

Date : *[Insert date (as day, month and year) of Bid Submission]*

Tender No. :

To : Director, IITM, Pune

We, the undersigned, declare that:

(a)	We have examined and have no reservations to the Bidding Documents, including Addenda No.: <i>[Insert the number and issuing date of each Addenda]</i>
(b)	We offer to supply in conformity with the Bidding Documents and in accordance with the Delivery Schedules specified in the Schedule of Requirements the following Goods and Related Services <i>[Insert a brief description of the Goods and Related Services]</i> as specified in Chapter 4
(c)	The total price of our Bid, excluding any discounts offered in item (d) below, is: <i>[Insert the total bid price in words and figures, indicating the various amounts and the respective currencies]</i>
(d)	The discounts offered and the methodologies for their application are: <b>Discounts.</b> If our bid is accepted, the following discounts shall apply. <i>[Specify in detail each discount offered and the specific item of the Schedule of Requirements to which it applies.]</i>
(e)	Our bid shall be valid for the period of time specified in ITB Clause 1.16, from the date fixed for the bid submission due date in accordance with ITB Clause 1.19 and it shall remain binding upon us and may be accepted at any time before the expiration of that period
(f)	If our bid is accepted, we commit to obtain a performance security in accordance with ITB Clause 1.41 and GCC Clause 2.12 for the due performance of the Contract
(g)	The following commissions, gratuities, or fees have been paid or are to be paid with respect to the bidding process or execution of the Contract: <i>[Insert complete name of each Recipient, its full address, the reason for which each commission or gratuity was paid and the amount and currency of each such commission or gratuity]</i>

Name of Recipient	Address	Reason	Amount
_____	_____	_____	_____
_____	_____	_____	_____
_____	_____	_____	_____

(If none has been paid or is to be paid, indicate “none.”)

(h)	We understand that this bid, together with your written acceptance thereof included in your notification of award, shall constitute a binding contract between us, until a formal contract is prepared and executed.
(i)	We understand that you are not bound to accept the lowest evaluated bid or any other bid that you may receive.

Signed : *[Insert signature of person whose name and capacity are shown]*  
In the capacity of *[Insert legal capacity of person signing the Bid Submission Form]*

Name : *[Insert complete name of person signing the Bid Submission Form]*

Duly authorized to sign the bid for and on behalf of: *[Insert complete name of Bidder]*

Dated on \_\_\_\_\_ day of \_\_\_\_\_, \_\_\_\_\_ *[Insert date of signing]*

**PERFORMANCE SECURITY FORM**

**MODEL BANK GUARANTEE FORMAT FOR PERFORMANCE SECURITY**

To,  
.....

**WHEREAS** .....  
(name and address of the supplier) (hereinafter called “the supplier”) has undertaken, in pursuance of contract no. .... dated .....to supply (description of goods and services) (herein after called “the contract”).

**AND WHEREAS** it has been stipulated by you in the said contract that the supplier shall furnish you with a bank guarantee by a scheduled commercial bank recognized by you for the sum specified therein as security for compliance with its obligations in accordance with the contract;

**AND WHEREAS** we have agreed to give the supplier such a bank guarantee;

**NOW THEREFORE** we hereby affirm that we are guarantors and responsible to you, on behalf of the supplier, up to a total of ..... (amount of the guarantee in words and figures), and we undertake to pay you, upon your first written demand declaring the supplier to be in default under the contract and without cavil or argument, any sum or sums within the limits of (amount of guarantee) as aforesaid, without your needing to prove or to show grounds or reasons for your demand or the sum specified therein.

We hereby waive the necessity of your demanding the said debt from the supplier before presenting us with the demand.

We further agree that no change or addition to or other modification of the terms of the contract to be performed there under or of any of the contract documents which may be made between you and the supplier shall in any way release us from any liability under this guarantee and we hereby waive notice of any such change, addition or modification.

This guarantee shall be valid until the .... day of ....., 20.....

(Signature of the authorized officer of the Bank)

.....  
Name and designation of the officer

.....  
Seal, name & address of the Bank and address of the Branch

**Note:** Whenever, the bidder chooses to submit the Performance Security in the form of Bank Guarantee, then he should advise the banker issuing the Bank Guarantee to immediately send by Registered Post (A.D.) an unstamped duplicate copy of the Guarantee directly to the Purchaser with a covering letter to compare with the original BG for the correctness, genuineness, etc.

**Acceptance certificate form**

No.

Dated:

M/s. \_\_\_\_\_  
 \_\_\_\_\_  
 \_\_\_\_\_

**Sub: Certificate of commissioning of equipment**

**01.** This is to certify that the equipment as detailed below has/have been received in good condition along with all the standard and special accessories (subject to remarks in Para 2). The same has been installed and commissioned.

(a)	Contract No. Date:	
(b)	Description of the equipment	
(c)	Name of the consignee	
(d)	Scheduled date of delivery of the consignment to the Laboratory / Institutes	
(e)	Actual date of receipt of consignment by the Laboratory / Institutes	
(f)	Scheduled date for completion of installation/commissioning	
(g)	Actual date of completion of installation/commissioning	
(h)	Penalty for late delivery (at Laboratory / Institutes level) Rs.	
(i)	Penalty for late installation (at Laboratory / Institutes level) Rs.	

**02** Details of accessories/items not yet supplied and recoveries to be made on that account:

Sr. No.	Description	Amount to be recovered

**03** The acceptance test has been done to our entire satisfaction. The supplier has fulfilled his contractual obligations satisfactorily

**OR**

The supplier has **failed to fulfil** his contractual obligations with regard to the following:

Sr. No.	Failure	Amount to be recovered
(a)		
(b)		
(c)		

The amount of recovery on account of failure of the supplier to meet his contractual obligations is as indicated at para03.

**For Supplier**

Signature .....

Name .....

Designation .....

Name of the firm .....

**For Purchaser**

Signature .....

Name .....

Designation .....

**INDIAN INSTITUTE OF TROPICAL METEOROLOGY**

Date .....

Date .....

## INDEMNITY BOND

No. \_\_\_\_\_

Date: \_\_\_\_\_

**1) Amalgamation/Acquisition**

In the event of M/s. \_\_\_\_\_ proposes for amalgamation, acquisition or sale of its business to any other firm during this contract period, M/s. \_\_\_\_\_ and proposed Buyer/Successor of the Principal Company are liable to execute, fulfill contractual obligations without any deviations. For this purpose M/s. \_\_\_\_\_/M/s. \_\_\_\_\_ and proposed Buyer/Successor of the Principal Company shall indemnify itself to the Director, INDIAN INSTITUTE OF TROPICAL METEOROLOGY , Pune to fulfill the contractual obligations as per the terms of the IITM Global Tender and quotation of M/s. \_\_\_\_\_ -No. \_\_\_\_\_ dated \_\_\_\_\_ and INDIAN INSTITUTE OF TROPICAL METEOROLOGY P.O. No. \_\_\_\_\_ dated \_\_\_\_\_. The contractual obligations are supply, installation, commissioning, warranty maintenance/replacement of spares, accessories etc. as per the above mentioned Purchase Order.

**2) Joint Venture, Consortium or Association**

If the Supplier is a joint venture, consortium, or association, all the parties shall be jointly and severally liable to the IITM for the fulfillment of the provisions of the Contract and shall designate one party to act as a leader with authority to bind the joint venture, consortium, or association. The composition or the constitution of the joint venture, consortium, or association shall not be altered without the prior consent of the IITM.

**3) Patent Indemnity**

The Supplier shall, subject to IITM's compliance and indemnify and hold IITM and its employees and officers harmless from and against any and all suits, actions or administrative proceedings, claims, demands, losses, damages, costs, and expenses of any nature, including attorney's fees and expenses, which IITM may suffer as a result of any infringement or alleged infringement of any patent, utility model, registered design, trademark, copyright, or other intellectual property right registered or otherwise existing at the date of the Contract by reason of: (a) the installation of the Goods by the Supplier or the use of the Goods in India; and (b) the sale in any country of the products produced by the Goods.

For M/s. \_\_\_\_\_  
Principal Supplier.

For M/s. \_\_\_\_\_  
Indian Agent.

**ANNEXURE-K**

**Eligibility Certificate**

This is to certify that we are not associated, or have been associated in the past, directly or indirectly, with a firm or any of its affiliates which have been engaged by the Purchaser to provide consulting services for the preparation of the design, specifications, and other documents to be used for the procurement of the goods to be purchased under this Invitation of Bids / Tender No. \_\_\_\_\_ dated \_\_\_\_\_.

Authorised Signatory

Name: \_\_\_\_\_

Designation: \_\_\_\_\_

**ANNEXURE-L**

**Non-Black listing Self Certificate**

This is to certify that M/s. \_\_\_\_\_ has not been blacklisted by any Central / State Government Department / organization in last 3 years.

Authorised Signatory

Name: \_\_\_\_\_

Designation: \_\_\_\_\_

**INDIAN INSTITUTE OF TROPICAL METEOROLOGY (IITM) PUNE**

**PROPOSED CONSTRUCTION OF STUDENTS HOSTEL BUILDING**

**TECHNICAL SPECIFICATION FOR CCTV SYSTEM**

**INDEX**

<b>SECTION</b>	<b>DESCRIPTION</b>	<b>PAGE NO.</b>
1	INTRODUCTION	2
2	TECHNICAL SPECIFICATIONS FOR CLOSE CIRCUIT TELEVISION SYSTEM	3
3	LIST OF APPROVED MAKES	15

## SECTION-1

### INTRODUCTION

#### GENERAL INFORMATION

CLIENT : M/s INDIAN INSTITUTE OF TROPICAL METEOROLOGY (IITM )  
PUNE

PROJECT TITLE : PROPOSED CONSTRUCTION OF STUDENTS HOSTEL BUILDING

SITE LOCATION : PUNE

SCOPE OF WORK : External CCTV Surveillance System



## SECTION-2

### TECHNICAL SPECIFICATION FOR CLOSED CIRCUIT TELEVISION SYSTEM

#### TECHNICAL SPECIFICATION FOR CLOSED CIRCUIT TELEVISION SYSTEM

##### 1. SCOPE:

- 1.1. The specification of Video Surveillance System covers technical specifications and requirement of True IP Video Surveillance System consisting of dome HD IP cameras, indoor & outdoor P/T/Z cameras, video management hardware & software, recording servers, storage, colour monitor etc. for surveillance of various locations of the UNMICRC.
- 1.2. The recording of the video shall be on an open architecture, non-embedded based recording server from reputed manufacturers like IBM/HP/Dell/Fujitsu.
- 1.3. The entire system shall be based on non-proprietary open architecture where the video management software can work and integrate with IT hardware and cameras. Similarly cameras should be compatible with minimum 10 brands of Video Management software.

##### 2.0 SYSTEM DESCRIPTION:

- 2.1 Video Surveillance System to be provided at various establishment shall consist of P/T/Z IP dome cameras, IP Dome Cameras , recording servers and PC's to view on Video Mosaic Wall Consisting of LED monitors and associated UTP cable, video cable, power cable, twisted pair cable etc.
- 2.2 It shall be possible to integrate the surveillance system using the existing LAN / WAN infrastructure on optical backbone network of the UNMICRC.
- 2.3 In IP video surveillance system, the IP cameras shall be deployed at different locations so that the captured video stream output is available on Ethernet and shall be sent via the backbone to the control room.
- 2.4 Each camera shall support video at HD (High Definition) and shall support a dual stream capability such that the viewing and recording at different resolutions and at different frames per second rates are possible.
- 2.5 True IP video surveillance system shall offer H.264 video compression standards.
- 2.6 System shall provide secured recording for evidence purposes and user authentication to protect data integrity.
- 2.7 The recording shall be preferably stored for at least 30 days at 4 CIF 25 frames per second for all cameras.

##### 3.0 GENERAL REQUIREMENTS:

- 3.1 Manufactured products shall have quality system compliance and shall be UL and EC and FCC certified.
- 3.2 The video management software should be able to integrate the hardware of other makes.
- 3.3 All IP cameras should be from the same manufacturer.

- 3.4 All software and firmware upgrades shall be free of cost for a period of five years or as specified by purchaser. All the IP cameras shall be freely accessible and programmable from the control room.
- 3.5 It shall be possible to view any camera from the multiple places simultaneously with no extra hardware & software. Connectivity for same shall be provided by the Institute. At least 5 number of users' licenses (or as specified by UNMICRC) shall be provided to view a camera from anywhere using the software.
- 3.6 Control room's system shall be capable of getting connected to the existing CCTV infrastructure.
- 3.7 The power supply available at the stations shall be 230 V / 50 Hz AC which may vary from 165 Volts to 270 Volts. All modules of the surveillance system should work using this power supply only with requisite converters & voltage stabilizers of suitable capacity, if required.
- 3.8 All the cameras and other components of video surveillance system shall be modular in construction. In case of up gradation of such modules in future, it shall be possible to upgrade them without replacing the entire product.
- 3.9 The system should have diagnostics facility for serial, video & network interfaces. System logging shall be possible either to a remote IP address or console port or on the system.
- 3.10 The entire system shall be running on TCP/IP Protocol with latest hardware & software. The system shall be monitored on quad screen. Each camera shall have the capability to be recorded at 4 CIF 25 FPS to 1080P. The Storage requirement shall be derived at 4 CIF resolution 25 fps or better for at least 30 days. Network Video Recorder and Printer will be installed at Control Room.

#### 4.0 HARDWARE REQUIREMENTS:

The Video Surveillance System shall mainly consist of:

##### 4.1 High Definition mini Dome Type IP Colour Camera:

- 4.1.1 High resolution IP HD Colour camera shall be of fixed dome type suitable for indoor & outdoor surveillance during day or low light (night) operation with inbuilt Audio & required housing bracket.
- 4.1.2 The camera must be work on PoE IEEE 802.3af or 802.3at.
- 4.1.3 The camera shall meet the following minimum technical requirements.

Sr No	Features	Specification(Minimum)	Compliance Y/N	Remark
1	Image Sensor	1/3" Megapixel progressive scan Exmor CMOS		
2	Effective Pixels	1920 (H) x 1080 (V)		
3	Minimum Illumination	0.5 Lux @ F1.6 (Color); 0 Lux @ F1.6 (IR LEDs on)		
4	IR Beam Distance	Max. 20m		
5	S/N Ratio	More than 50db		

6	Gain Control	Auto / Manual		
7	Electronic Shutter Speed	Auto/Manual (1/3~1/120000s)		
8	Lens Type	3.6 mm Fixed, F1.6		
9	Horizontal Angle of View	88°		
10	White Balance	Auto / Day / Night / Customized		
11	Backlight Compensation	BLC / DWDR		
12	Exposure Mode	Manual / Low noise / Low motion blur / Auto		
13	Ranges from	1/3 to 1/12000		
14	Noise Reduction	3D Noise Reduction		
15	Video Flip Mirror function and flip function	Required		
16	Privacy Mask	4 zones		
17	Video Information Channel	title; time title; motion detection; privacy mask		
18	Motion Detection	396 (18 x 22) detection zones; Sensitivity level ranges from 0 to 120; area threshold ranges from 0 to 120.		
19	Activation event:	video storage; image snapshot; log; email function		
20	Watermark Support	Required		
21	Video Compression	H.264 / MJPEG		
22	Primary Stream Resolution	1080p (1920 x 1080) / SXGA (1280 x 1024) / 1.3M (1280 x 960) / 720p (1280 x 720) / D1 (704 x 576 / 704 x480) / CIF (352 x 288 / 352 x 240)		
23	Frame Rate Main Stream:	1080p / SXGA / 1.3M / 720p / D1 @25/30fps		
24	Sub Stream:	D1 / CIF@25/30 fps		

25	Video Bit Rate	1280K ~ 8192 Kbps @ 1080p		
26	Security	Up to 20 users, multiple user access levels with password protection		
27	Supported Protocols	IPv4/IPv6, HTTP, HTTPS, SSL, TCP/IP, UDP, UPnP, ICMP, IGMP, SNMP, RTSP, RTP, SMTP, NTP, DHCP, DNS, PPPOE, DDNS, FTP, IP Filter, QoS, Bonjour		
28	Standards ONVIF Profile S	Required		
29	Power Supply	12 V DC PoE IEEE 802.3af, Type 1, Class 3		
30	Certifications	CE,FCC, UL		

**4.2 High Definition IR Bullet Type IP Colour Camera:**

Sr No	Features	Specification(Minimum)	Compliance Y/N	Remark
1	Type	Bullet		
2	Resolution	720p		
3	Weatheproof	IP 66 Weather Proof		
4	Lens	2.8 - 12mm 2M DC-IRIS		
5	Image Sensor	Sony 1/3" Exmor™ image sensor		
6	Effective Pixels	1280 x 720 pixels		
7	Memory Card	32 GB		
8	WDR	80 dB		
9	Frame Rate	1fps-25/30fps		
10	Encoding	MainProfile/Baseline Level 4		
11	Main Stream	HD 720P(1280*720)/ Q1080P(960*540)		

12	Second Stream	Q720P(640*360) VGA(640*480) QVGA(320*240) D1:PAL(720*576)NTSC(720*480) CIF:PAL(352*288)NTSC(352*240) QCIF:PAL(176*144)NTSC(176*120)		
13	Bit Rate	16-8000kbps		
14	Min. Illumination	IR LED ON: 0 Lux IR LED OFF: Color: 0.01 Lux @ F1.4 (AGC ON) B/W: 0.001 Lux @ F1.4 (AGC ON)		
15	IR LED	2 matrix IR LEDs. IR ON when below 3 Lux		
16	IR Beam Distance	30 - 40 m		
17	Video Compression	H.264, and MJPEG simultaneously (Dual-encoders)		
18	Video Profile	H.264 Baseline, Main		
19	Profile Setting	Every video profile has Independent CBR/ VBR/ GOP/ Frame rate setting		
20	Main Stream Resolution	720P (1280 x 720), Q1080P (960 x 544)		
21	Second Stream Resolution	D1 (720 x 576), VGA (640 x 480), Q720P (640 x 360), CIF (352 x 288), QVGA (320 x 240), QCIF (176 x 144)		
22	Electronic Shutter	Auto mode: 1/25 - 1/30000 sec Manual mode: 1/25 - 1/10000 sec		
23	Iris Exposure Control	Auto mode / Manual mode		
24	AGC	LOW/MID-LOW/MID/MID-HIGH/HIGH		
25	WDR Mode	OFF/LOW/MID/HIGH		
26	3-DNR	OFF/LOW/MID/HIGH		
27	Color Mode	Normal/Natural/Bright		
28	Image Setting	AE, AWB; 3D Noise reduction; WDR; Color, brightness, sharpness, contrast, Hue; Mirror/Flip; Privacy Masks; Text, time and date overlay		

29	Streaming	Simultaneously multi-profile streaming; Streaming over UDP, TCP, HTTP, or HTTPS; M-JPEG streaming over HTTP (server push); Controllable frame rate and bandwidth; Constant and variable bit rate (MPEG4 / H.264)		
30	On Screen Display	Text, time and date overlay		
31	Audio Encoder	RTSP: G.711 64kbps		
32	Audio Streaming	One-way or two-way		
33	Audio Input	External audio in		
34	Audio Output	Speaker Out		
35	Supported Protocols	IPv4, IPv6, TCP, UDP, HTTP, HTTPS, SMTP, FTP, NTP, DNS, DDNS, DHCP, ARP, Bonjour, UPnP, RTSP, RTP, RTCP, IGMP, PPPoE, ICMP, SNMP		
36	Security	Password protection, HTTPS encrypted data transmission, user access log		
37	Users	4 simultaneous unicast users		
38	Ethernet	10/100M auto negotiation		
39	Supported Interface	ONVIF Profile S		
40	Event Detection	Alarm in, motion detection, Network loss detection, camera tampering, Video loss		
41	Motion Detection	1-zone video motion detection with Sensitivity options		
42	Privacy Mask	4-Zone		
43	Camera Tampering	Camera Cover or Mask		
44	Events Action	SNAP, Record video in SD card, send to FTP, send to Email, External output activation, voice alert, notify to CMS		
45	OS	Windows XP or later		
46	Browser	IE 8.0 or later		

47	Supported Platform	Honeywell Universal Surveillance (HUS) and NVRs		
48	Power Supply	12V DC or 24V AC ±10% external power adapter		
49	PoE	IEEE 802.3af		
50	Power consumption	Max 10W		
51	Connectors	RJ-45 10Base-T/100Base-TX; 1 power jack; 2 alarm input and 1 output; Audio out; Audio input; Video out; SD card, and RS485		
52	Edge Storage	32G		
53	Certification	UL, CE & FCC		
54	Operating Temperature	-20°C to 55°C		
55	Operating Humidity	0% - 90% (non-condensing)		

#### 4.3 Outdoor High Speed HD PTZ 30 X or better IP Color Camera– IP66 (Day/Night):

Sr No	Features	Specification(Minimum)	Compliance Y/N	Remark
1	Image Sensor	1/4" CMOS 1.3M		
2	Optical Zoom	30X		
3	Digital Zoom	OFF / ON (X2 ~ X12)		
4	Effective Pixels	1280 (H) x 720 (V)		
5	S/N Ratio	50dB		
6	Min. Illumination	IR LED ON - 0 Lux IR LED OFF - Color: 0.15 Lux, F1.35 (50 IRE AGC ON) B/W: 0.01 Lux, F1.35 (50 IRE AGC ON)		
7	Focus length	f=3.5 - 101.5mm		
8	Angle Field of view	H: Appr. 54.8° (Wide) to 2.01° (Tele)		
9		V: Appr. 44.6° (Wide) to 1.61° (Tele)		
10	Focus Mode	Auto / Manual		

11	White Balance	ATW / INDOOR / OUTDOOR		
12	Iris Control	Auto / Manual		
13	Electronic Shutter	1/30(1/25) - 1/33,000s		
14	AGC Control	LOW, MIDDLE, HIGH		
15	Backlight Compensation	OFF / BLC / HLC		
16	Digital Slow Shutter	Sens-up: AUTO/ OFF (2 - 60X selectable)		
17	Motion Detection	ON / OFF (programmable zones)		
18	Wide Dynamic Range	ON / OFF		
19	Day/Night	Auto (ICR)		
20	Image Inverse	OFF / V-rotation / H-rotation / Flip		
21	Noise Reduction	LOW / MIDDLE / HIGH / OFF		
22	Electronic Image Stabilizer	ON / OFF		
23	Pan travel	360°endless		
24	Tilt travel	0 - 90°		
25	Manual Speed	0.1° - 150°/s		
26	Presets	256		
27	Preset Accuracy	0.1°		
28	Preset Speed	180°/s		
29	Swing	8		
30	Continuous	Support		
31	Cruise	8		
32	Pattern	4		
33	Privacy Mask	8		
34	Proportional Pan & Tilt	Auto		
35	Home Function	Preset / Swing / Cruise / Pattern		
36	Auto Flip	Mechanical		
37	Resume after Power Loss	Support		



38	IR Beam Distance	100m		
39	IR Angle	Adjustable by zoom		
40	Main Stream Resolution	720P (1280 x 720), Q1080P (960 x 544)		
41	Second Stream Resolution	D1 (720 x 576), VGA (640 x 480), Q720P (640 x 360), CIF (352 x 288), QVGA (320 x 240), QCIF (176 x 144)		
42	Bit Rate	16 - 8000kbps		
43	Frame Rate	1fps - 25/30fps		
44	Video Compression	H.264 baseline, main, high profile/ MJPEG dual stream		
45	Encoding Control	CBR / VBR / GOP		
46	Video Output	1.0Vp-p complex video output,75Ohm		
47	Network Protocols	IPv4, TCP, UDP, HTTP, HTTPS, SMTP, FTP, NTP, DNS, DDNS, DHCP, ARP, UPnP, RTSP, RTP, RTCP, PPPoE, ICMP, SNMP		
48	Supported Protocol	ONVIF Profile S		
49	Alarm Input	2 channels		
50	Alarm Output	1 channel, support alarm linkage		
51	Alarm Linkage	SD card video recording / FTP Upload / Email / Snapshot / Preset / Alarm output / CMS		
52	Audio	1 channel input, 1 channel output, monitoring and talkback		
53	Audio Compression	G.711ulaw / ADPCM		
54	RS485	Half-duplex, support Pelco P and Pelco D		
55	Supported Platform	Honeywell Universal Surveillance (HUS) and NVRs		
56	Power Supply	DC12V5A ±10%		
57	Power Consumption Indoor:	50W (IR LED and heater ON)		

58	Edge Storage	Max 32G, support NFR		
59	Operation Humidity	0 - 90% RH (non-condensing)		
60	Protection	IP66		
61	Regulatory	UL,CE, FCC		

## 5.0 MONITORS:

### Plasma/LED Television:

Size	32" diagonal
Resolution	1024 x 768 Pixels – MINIMUM
Voltage	230 V AC
Mounting type	<b>Suitable for Wall</b> <b>flexible wall bracket for better serviceability</b>
Remote control	To be provided
Built in speaker	To be provided - 2 nos
Input	Composite video, S Video, SVGA, Co-axial cable, Stereo Audio in and suitable PC input (15 Pin)
Output	4 Audio out, Video out
Power Cord	To be provide with earth pin.

## 6.0 SOFTWARE REQUIREMENTS :

### 6.1 Network Video Management Software:

- 6.1.1 This shall be a highly scalable enterprise level software solution. It shall offer a complete video surveillance solution that will be scalable to required numbers of cameras that can be added on a unit-by-unit basis.
- 6.1.2 Total number of software recording licenses to be provided per site has to be of the same number as cameras.
- 6.1.3 The network video management software shall be licensed and shall operate on open architecture and should require no proprietary hardware. It should allow for seamless integration of third party security infrastructure where ever possible.
- 6.1.4 The network video management software should allow for video to be streamed on a video mosaic wall.
- 6.1.5 The user with administrative rights shall create clients (users) and give access to the software client application based on predefined user access rights.
- 6.1.6 The system shall allow the recording, live monitoring, playback of archived video and data simultaneously.
- 6.1.7 The software shall provide the following:

- 6.1.7.1 Several simultaneous live picture connections of camera in network.
- 6.1.7.2 Configuration of monitoring situation (site maps and workspace).
- 6.1.7.3 Programming of alarm-triggered automatic events in AND, NAND, OR & NOR configuration.
- 6.1.7.4 System set up with limited operation options for clearly defined surveillance tasks.
- 6.1.7.5 Programming of automatic recording events on a network recorder.
- 6.1.8 The software shall display H.264 video streams in real time simultaneously at frame rates ranging from 1 fps to 25 fps and resolution ranging from CIF to 2.4 Megapixel.
- 6.1.9 Each camera's bit rate, frame rate and resolution shall be set independently from other cameras in the system, and altering these settings shall not affect the recording and display settings of other cameras.
- 6.1.10 The software shall provide automatic search and registration of components of video surveillance system on the network which can be cameras, monitors, alarm panels etc.
- 6.1.11 The software shall provide drag & drop functions on the system and also for set up of connection between cameras and monitors.
- 6.1.12 The software shall allow:
  - 6.1.12.1 Live display of cameras.
  - 6.1.12.2 Live display of camera sequences.
  - 6.1.12.3 Control of PTZ cameras.
  - 6.1.12.4 Playback of archived Video & Audio.
  - 6.1.12.5 Retrieval of archived Video & Audio.
  - 6.1.12.6 Instant Replay of live Video & Audio.
  - 6.1.12.7 Use of site maps.
  - 6.1.12.8 Use of Macros
  - 6.1.12.9 Configuration of system settings.
  - 6.1.12.10 Configuration and programming of P/T/Z cameras, features like camera addressing, BLC, auto tours, presets etc.
- 6.1.13 The software should be able to do video recording on any of the following options - inbuilt hard disks on the server, direct attached Storage boxes attached to servers, network attached storage, storage area network.
- 6.1.14 The software should be capable of handling camera and alarm icons on area maps. The area map should be configurable to pop up upon the receipt of an alarm received from a camera on the map. This can be on the same or other monitors on the PC.
- 6.1.15 The software should be able to carry out a motion search on recorded video and highlight motion in the playback bar and should also provide motion event based thumbnails to navigate straight to that event in recording.
- 6.1.16 The software shall offer a plug and play type hardware discovery service with the function of automatically discover devices as they are attached to the network.

- 6.1.17 The software shall provide a reporting utility for tracking for the following minimum options. Video and images shall be stored with reports for documenting events.
- 6.1.17.1 Alarms
  - 6.1.17.2 Incidents
  - 6.1.17.3 Operator logs
- 6.1.18 The software shall provide file export tool for export of single frames of video in J-PEG/ BMP or better file formats and for export of motion video files in media player compatible file format for transport and playback on computers utilizing a Window environment.
- 6.1.19 The software database servers shall not limit the number of network video recording servers which can be networked together to form video management and recording system.
- 6.1.20 The software database server shall maintain a catalog of settings for all the clients, servers, and IP cameras & IP enabled cameras in the system. If database management & recording cannot be managed by single server, in such cases, additional server should be provided.
- 6.1.21 The software shall enable the client to dynamically create connections between cameras and clients and view live or recorded video on the digital VGA monitors (video, serial ports and digital I/Os).
- 6.1.22 The software shall provide the client seamless operation of all cameras and clients available in the system regardless of the actual connection to different Network Video Recording servers.
- 6.1.23 The software shall detect signal loss, low signal to noise ratio, too bright scene or too dark scene and have the capability to alert the systems administrator.
- 6.1.24 The software shall receive all incoming events (motion detection and triggered digital input and relay output) in the system and take appropriate actions based on user-defined event/action relationships.
- 6.1.25 The software shall create an audit trail of all events and user activities.
- 6.1.26 The software shall support a built-in Virtual Video Matrix Switcher.
- 6.1.26.1 The Virtual Matrix Switch shall provide a full matrix operation of IP video to analog output.
  - 6.1.26.2 The Virtual Matrix Switch shall provide a full matrix operation of IP video to digital monitors.
  - 6.1.26.3 The Virtual Matrix Switch shall have the capability of creating camera sequences with the following functionalities:

- 6.1.26.3.1 Each Sequence shall have capability up to hundreds of cameras.
- 6.1.26.3.2 Each camera in the sequence shall have its own individual dwell time, from 1 to 60 seconds.
- 6.1.26.3.3 Each entry in a sequence shall have the capacity to trigger PTZ camera presets, patterns or auxiliaries.
- 6.1.26.3.4 Multiple users shall be able to view the same camera sequence simultaneously, not necessarily synchronized one with the other.
- 6.1.27 The software shall provide alarm management module.
- 6.1.27.1 The alarm management shall be able to set any monitor or groups of monitors to automatically display cameras in response to alarm inputs.
- 6.1.27.2 The alarm management shall be able to reset automatically or manually alarmed video.
- 6.1.28 The software shall support absolute redundancy with 1 to N, N to 1 and N to N redundancy configurations. All this should be provided without licensing.
- 6.1.28 The software should allow for time-synchronized playback of different cameras together in the same video pane. This should enable the operator to watch playback of an event in an area covered by multiple cameras from different angles as the event happens.
- 6.1.30 The software should support at least 64 video streams concurrently. It should support atleast 4 monitors for displaying live video. It should allow minimum 5 levels of user and alarm prioritization. It should allow up to 32 cameras to be replayed simultaneously.

## **6.2 Network Video Recording Software:**

- 6.2.1 Software shall support recording of H.264 video streams. It shall support recording of video and audio for all the channels as well as It could convert and download into AVI, MPEG4 or lower Video File formats too.
- 6.2.2 Software shall support triplex applications, recording, re-play and backup simultaneously. It shall be compatible with windows OS or Linux for highest performance and reliability.
- 6.2.3 Software shall operate on open architecture and should not require any proprietary hardware.
- 6.2.4 Software shall be able to record minimum 32 different video streams or more simultaneously. It shall be accessible from any PC connected to the network.
- 6.2.5 Software shall provide network time server function to ensure the synchronisation of the video servers and the recordings.
- 6.4.6 The servers shall be connected to the network so that these can be placed at any location which has network access.
- 6.2.7 The software should be able to receive alarms of different types from video servers to start a recording. These alarms can be motion detection, video loss, and unified picture, trigger input.

- 6.2.8 The software alarm recording shall support pre-and post-alarm periods. Both can be configured in duration.
- 6.2.9 The software should provide a status of the available recording capacity, as well as an indication of the remaining possible recording time.

#### **6.2.10 Fault Tolerant Recording and Software Failover Option:**

- 6.2.10.1 If software & server(s) operation are interrupted, like power disconnection and once the server(s) are restarted, these shall automatically resume recording of any cameras these were recording prior to the interruption.
- 6.2.10.2 The software shall support network fault-tolerant recording such that if the network connection between a video management server and video recording server becomes unavailable, for example through cable breakage, network congestion or WLAN interruption, the system operation shall automatically recover when the connection is restored.
- 6.2.10.3 System should be configurable with redundant recording without any additional licensing. In case of failure of one recording system, a second recording server should overtake automatically

#### **6.2.11 Search & Export:**

- 6.2.11.1 It shall be possible to search for recordings in the software by camera, date and time. If a data and time is specified, playback shall commence from that date and time. It shall be possible to playback more than one camera simultaneously.
- 6.2.11.2 The software shall be able to export sections of recordings to a separate Windows folder, which can then be written to CD-ROM, DVD-ROM or tape media to be played back at a location not connected to the network video management & recording network. The export process should make available a player application, which can be provided with the exported video. Export should be possible in Windows media player compatible format. Simultaneous export of multiple cameras should also be possible.

### **6.3 GUI (Graphic User Interface) Client Software Features:**

The Graphical User Interface shall allow the following:

- a. Live display of cameras.
- b. Live display of camera sequences, salvos and guard tours.
- c. Control of PTZ cameras.
- d. Playback of archived Video at speeds of x1/4 – x16.
- e. Retrieval of archived Video using normal playback, thumbnails (event or time based).
- f. Instant Replay of Live Video & Audio.
- g. Use of site maps.
- h. Configuration of system settings.
- i. Execution of Salvos, Guard Tour & sequences using tasks or manually.

**SECTION – 3**

**LIST OF APPROVED MAKES**

<b>S. No</b>	<b>Name of components</b>	<b>Recommended makes</b>
1	Copper cables for signal and power	Teleflex / Finecore/ Varsha / Technoflex
2	MS conduits	Bharat/Gupta/ Vimco / AKG / Supreme
3	Plasma /LED – Continues duty	Sony, Panasonic, Samsung
4	PC Workstation	DELL /HP / IBM
5	CCTV Equipments and software	Sony / BOSCH /Panasonic
6	NVR FOR CCTV RECORDING	BOSCH/HONEYWELL
7	CAT-6 CABLES /PATCH CHORD/I-O SOCKETS	MOLEX/AMP /AVAYA
8	NETWORK SWITCH	ALLIED TELESIS / AVAYA
9	Rack	HCL/ APC /WALLRACK
10	PVC Pipe	Avon plast/VIP/Precision/Modi/Diamond.

**\* Though the recommended make mentioned above, bidders can quote its equivalent make also.**

**INDIAN INSTITUTE OF TROPICAL METEOROLOGY (IITM ) PUNE**

**PROPOSED CLOSED CIRCUIT TELEVISION SYSTEM EQUIPMENT FOR STUDENTS HOSTEL BUILDING**

Sl.No	DESCRIPTION	UNIT	QTY	Details of the item quoted including make, model, type (wherever applicable) and general specifications	Whether complied with required specification – or deviation of any
<b>I</b>	<b>CLOSED CIRCUIT TELEVISION SYSTEM EQUIPMENT</b>				
	<b>Supply, intallation, testing and Commissioning of the following system as per the technical specification.</b>				
1	1080P IP indoor Dome Camera, 1/3" progressive scan Exmor CMOS, H.264, 3 mm - 10 mm, F1.6,DC Iris , D/N,DWDR, ONVIF Profile, PoE,133 dB wider dynamic range Audio chip and IR. The rate shall inclusive of bracket, indoor housing and mounting accessories and minimum 20 Mtr IR range	5	Nos		
2	1080P IP Outdoor Gun type Camera, 1/3" progressive scan Exmor CMOS, H.264, 2.7-12mm Varifocal Lens & Long Lead,DC Iris, F1.6, TDN, DWDR, ONVIF Profile S, PoE, Audio chip and IR. The rate shall inclusive of support bracket, Lenz, outdoor housing ,mounting accessories and minimum 20 Mtr IR range, etc., (Suitable for 50 mtr coverage distance)	16	Nos		
3	High resolution 1/4" CMOS, 720P (1280 x 720), H.264,3.5 - 101.5mm Varifocal Lens & Long Lead,DC Iris, F1.6, TDN, DWDR, ONVIF Profile S, PoE, Audio chip and IR, IP-66 standard, high strength metal housing, heater and fan, IR LED ON - 0 Lux IR LED OFF -Color: 0.15 Lux, F1.35 (50 IRE AGC ON) B/W: 0.01 Lux, F1.35 (50 IRE AGC ON) with 36X optical Zoom, 12x Digital Zoom, receiver, driver, Pan/Tilt and necessary mounting support / bracket, accessories as required for outdoor installation along with standard outdoor enclosure with suitable accessories and mounting support as per specification. (Suitable for 75 to 150 mtr coverage distance-)	1	Nos		
4	Network Video Recording Storage System: Supports 64 channels video recording and video playback or relay. Support 16 hot-swappable hard disk direct attached and up to total 48 disks expansion. Total Hard Disk Capacity included - 64TB.The rate shall inclusive of necessary 4CIF, 12 frame /second - 30 days and Raid-5 technology with 5 user client licence. (server+VMS+inbuilt 16HDD Bays for up to 64TB Storage).	1	Nos		
5	Client Workstation with Client Software:- Monitoring station as per technical specification and system PC comprising Intel core i 7- 3.33 Ghz Processor @ L2 Cache 3 MB Intel 31 PR mother board, 4GB DDr2 RAM @ 667 Mhz , 500 GB HDD , Keyboard, Optical mouse, external speakers, 4TB External hard disc ,sound card ATX P IV Cabinet with SMPS Prime Source,	1	Nos		



	DVD Writer, Service pack -1 with Windows 7 professional operating system. The system should be supplied with 23" TFT Color Monitor. The Server should be loaded with antivirus software. It shall have minimum 3 serial and 1 parallel port operation facility .The CPU shall have a LAN card with 2 USB ports with dual monitor card . One set of speakers with necessary interconnection wires. The system shall be provided with pre-loaded antivirus software and PC configuration should be considered latest at time of installation stage.-				
6	Network Joystick for PTZ Operation control suitable for PTZ camera - Security control room (Model no:- Bosch KBD Digital)	1	Set		
	<b>NETWORK (CAT-6 CABLES/PATCH CHORD/I-O SOCKETS:ADC KRONE /NEXANS /SYSTIMAX/AMP NETWORK SWITCH:NORTEL/AVAYA /JUNIPER/HCL</b>				
7	Supply, installation, testing and commissioning of Stackable Edge Switch with layer-2 12 ports (12 nos POE port for CCTV System) including redundant power supply.	3	Each		
8	6U wall mounted rack made out of powder cated materials with Air conditioning, glass door in front side. The rack shall be provided with suitable power sockets/strips, lock and key, cable manager etc	3	Each		
9	12U wall mounted rack made out of powder cated materials with Air conditioning, glass door in front side. The rack shall be provided with suitable power sockets/strips, lock and key, cable manager etc	1	Each		
10	32" diagonal, 1920 x 1080 pixels LCD television with all mounting bracket, connection card wire, remote control etc as per the specification.	1	Nos		
11	4 Mtr height GI post with necessary mounting bracket and Civil works for external cameras.(Above Ground Level)	10	Nos		
	<b>Total `I' C/o to Summary</b>				

**INDIAN INSTITUTE OF TROPICAL METEOROLOGY (IITM ) PUNE**

**PROPOSED CONSTRUCTION OF STUDENTS HOSTEL BUILDING**

**BILL OF QUANTITIES FOR CLOSED CIRCUIT TELEVISION SYSTEM EQUIPMENT**

Sl.No	DESCRIPTION	QTY	UNIT	RATE IN INR		AMOUNT IN INR		TOTAL AMOUNT IN INR
				SUPPLY	ERECTION	SUPPLY	ERECTION	
<b>I</b>	<b>CLOSED CIRCUIT TELEVISION SYSTEM EQUIPMENT</b>							
	<b>Supply, intallation, testing and Commissioning of the following system as per the technical specification.</b>							
1	1080P IP indoor Dome Camera, 1/3" progressive scan Exmor CMOS, H.264, 3 mm - 10 mm, F1.6,DC Iris , D/N,DWDR, ONVIF Profile, PoE,133 dB wider dynamic range Audio chip and IR. The rate shall inclusive of bracket, indoor housing and mounting accessories and minimum 20 Mtr IR range	5	Nos					
2	1080P IP Outdoor Gun type Camera, 1/3" progressive scan Exmor CMOS, H.264, 2.7-12mm Varifocal Lens & Long Lead,DC Iris, F1.6, TDN, DWDR, ONVIF Profile S, PoE, Audio chip and IR. The rate shall inclusive of support bracket, Lenz, outdoor housing ,mounting accessories and minimum 20 Mtr IR range, etc., (Suitable for 50 mtr coverage distance)	16	Nos					
3	High resolution 1/4" CMOS, 720P (1280 x 720), H.264,3.5 - 101.5mm Varifocal Lens & Long Lead,DC Iris, F1.6, TDN, DWDR, ONVIF Profile S, PoE, Audio chip and IR, IP-66 standard, high strength metal housing, heater and fan, IR LED ON - 0 Lux IR LED OFF - Color: 0.15 Lux, F1.35 (50 IRE AGC ON) B/W: 0.01 Lux, F1.35 (50 IRE AGC ON) with 36X optical Zoom, 12x Digital Zoom, receiver, driver, Pan/Tilt and necessary mounting support / bracket, accessories as required for outdoor installation along with standard outdoor enclosure with suitable accessories and mounting support as per specification. (Suitable for 75 to 150 mtr coverage distance-)	1	Nos					
4	Network Video Recording Storage System: Supports 64 channels video recording and video playback or relay. Support 16 hot-swappable hard disk direct attached and up to total 48 disks expansion. Total Hard Disk Capacity included - 64TB.The rate shall inclusive of necessary 4CIF, 12 frame /second - 30 days and Raid-5 technology with 5 user client licence. (server+VMS+inbuilt 16HDD Bays for up to 64TB Storage).	1	Nos.					

5	Client Workstation with Client Software:- Monitoring station as per technical specification and system PC comprising Intel core i 7- 3.33 Ghz Processor @ L2 Cache 3 MB Intel 31 PR mother board, 4GB DDr2 RAM @ 667 Mhz , 500 GB HDD , Keyboard, Optical mouse, external speakers, 4TB External hard disc ,sound card ATX P IV Cabinet with SMPS Prime Source, DVD Writer, Service pack -1 with Windows 7 professional operating system. The system should be supplied with 23" TFT Color Monitor. The Server should be loaded with antivirus software. It shall have minimum 3 serial and 1 parallel port operation facility .The CPU shall have a LAN card with 2 USB ports with dual monitor card . One set of speakers with necessary interconnection wires. The system shall be provided with pre-loaded antivirus software and PC configuration should be considered latest at time of installation stage.-	1	Nos.					
6	Network Joystick for PTZ Operation control suitable for PTZ camera - Security control room (Model no:- Bosch KBD Digital)	1	Set					
	<b>NETWORK (CAT-6 CABLES/PATCH CHORD/I-O SOCKETS:ADC KRONE /NEXANS /SYSTIMAX/AMP NETWORK SWITCH:NORTEL/AVAYA /JUNIPER/HCL</b>							
7	Supply, installation, testing and commissioning of Stackable Edge Switch with layer-2 12 ports (12 nos POE port for CCTV System) including redundant power supply.	3	Each					
8	6U wall mounted rack made out of powder cated materials with Air conditioning, glass door in front side. The rack shall be provided with suitable power sockets/strips, lock and key, cable manager etc	3	Each					
9	12U wall mounted rack made out of powder cated materials with Air conditioning, glass door in front side. The rack shall be provided with suitable power sockets/strips, lock and key, cable manager etc	1	Each					
10	32" diagonal, 1920 x 1080 pixels LCD television with all mounting bracket, connection card wire, remote control etc as per the specification.	1	Nos					
11	4 Mtr height GI post with necessary mounting bracket and Civil works for external cameras.(Above Ground Level)	10	Nos					
	<b>Total 'I' C/o to Summary</b>						-	-

**(This sheet may please be left as blank while submitting along with Technical Bid, but may be filled in while submitting in Commercial Bid along with Commercial Bid format as stated on page no. 40).**

INDIAN INSTITUTE OF TROPICAL METEOROLOGY (IITM ) PUNE					
PROPOSED CONSTRUCTION OF STUDENTS HOSTEL BUILDING					
BILL OF QUANTITIES FOR CLOSED CIRCUIT TELEVISION SYSTEM CABLING WORKS					
Sl.No	DESCRIPTION	UNIT	QTY	Details of the item quoted including make, model, type (wherever applicable) and general specifications	Whether complied with required specification – or deviation of any
<b>I</b>	<b>CABLING WORKS FOR CLOSED CIRCUIT TELEVISION SYSTEM</b>				
	<b>Supply, intallation, testing and Commissioning of the following system as per the technical specification.</b>				
<b>1</b>	<b>CABLES</b>				
2	Supply, laying, termination of CAT-6 E UTP cable 4 pair as per the technical specification	2500	Mtr		
3	Supply, fixing of CAT 6 E patch cords of 3 feet	35	Each		
4	Supply and fixing of Single I/O face plate with RJ 45 connectors with suitable base box	35	Each		
5	Supply and fixing of 25mm dia FRLS MS pipes/flexible layed /clamped in the existing wall/cable tray with suitable supports for CAT-6 cables	1500	Mtr		
6	Excavation of ground to a depth of 3' level and width of 1' and refilling elc.for laying the PVC piping/Direct cable. Extra earth after fe-filling to be leveled in low lying area as directed by the Site incharge. (For Perimeter fencing)	400	Mtrs		
7	110 mm dia 6Kg/cm2 PVC pipe in excecavated ground. The rate shall including necessary coupler, bend etc.	400	Mtr		
8	construction of 600mm x 600mm inspection chamber with cover for PVC pipes at every 100 feet distance for taking the cable from building to building.	6	Each		
9	Supply, laying, termination of Fibre optic cable between Switches and necessary socket for connecting the switches and NVR	175	Mtr		
<b>10</b>	<b>WIFI System</b>				
a	Supplying, installation, testing and commissioning of 4-pair, Cat6-- UTP Cable, in exisitng laid concealed/surface conduits /cables trays/pvc Casing capping etc. The cat 6 cable shall be as per standard of ANSI/ TIA-568-C2-	1000 0	Mtr		

b	Supplying and erecting PVC trunking (PVC casing-ncapping) of size 25 mm with accessories on wall/ceiling as	200	Mtr		
	<b>Total `I' C/o to Summary</b>				

**INDIAN INSTITUTE OF TROPICAL METEOROLOGY (IITM ) PUNE**

**PROPOSED CONSTRUCTION OF STUDENTS HOSTEL BUILDING**

**BILL OF QUANTITIES FOR CLOSED CIRCUIT TELEVISION SYSTEM CABLING WORKS**

Sl.No	DESCRIPTION	QTY	UNIT	RATE IN INR		AMOUNT IN INR		TOTAL AMOUNT IN INR
				SUPPLY	ERECTION	SUPPLY	ERECTION	
<b>1</b>	<b>CABLING WORKS FOR CLOSED CIRCUIT TELEVISION SYSTEM</b>							
	<b>Supply, intallation, testing and Commissioning of the following system as per the technical specification.</b>							
1	<b>CABLES</b>							
2	Supply, laying, termination of CAT-6 E UTP cable 4 pair as per the technical specification	2500	Mtr					
3	Supply, fixing of CAT 6 E patch cords of 3 feet	35	Each					
4	Supply and fixing of Single I/O face plate with RJ 45 connectors with suitable base box	35	Each					
5	Supply and fixing of 25mm dia FRLS MS pipes/flexible layed /clamped in the existing wall/cable tray with suitable supports for CAT-6 cables	1500	Mtr					
6	Excavation of ground to a depth of 3' level and width of 1' and refilling elc.for laying the PVC piping/Direct cable. Extra earth after fe-filling to be leveled in low lying area as directed by the Site incharge. (For Perimeter fencing)	400	Mtrs					
7	110 mm dia 6Kg/cm2 PVC pipe in excavated ground. The rate shall including necessary coupler, bend etc.	400	Mtr					
8	construction of 600mm x 600mm inspection chamber with cover for PVC pipes at every 100 feet distance for taking the cable from building to building.	6	Each					
9	Supply, laying, termination of Fibre optic cable between Switches and necessary socket for connecting the switches and NVR	175	Mtr					
10	<b>WIFI System</b>							
a	Supplying, installation, testing and commissioning of 4-pair, Cat6-- UTP Cable, in exisiting laid concealed/surface conduits /cables trays/pvc Casing capping etc. The cat 6 cable shall be as per standard of ANSI/ TIA-568-C2-	10000	Mtr					
b	Supplying and erecting PVC trunking (PVC casing-ncapping) of size 25 mm with accessories on wall/ceiling as	200	Mtr					
	<b>Total `I' C/o to Summary</b>					-	-	-

**(This sheet may please be left as blank while submitting along with Technical Bid, but may be filled in while submitting in Commercial Bid along with Commercial Bid format as stated on page no. 40 ).**

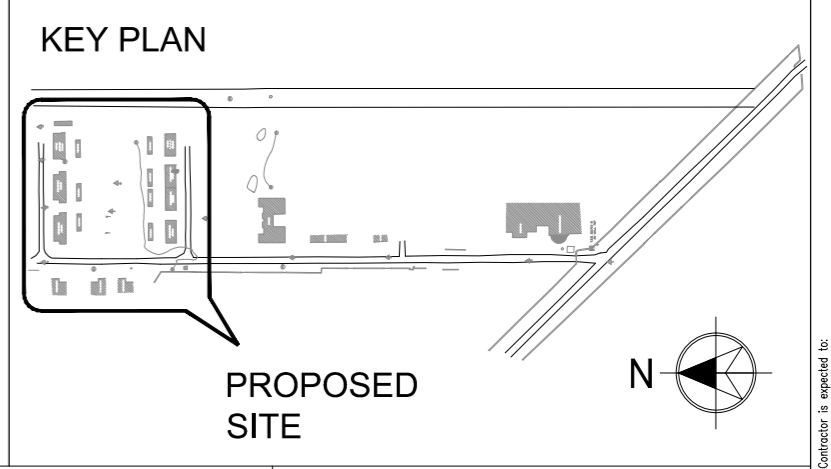
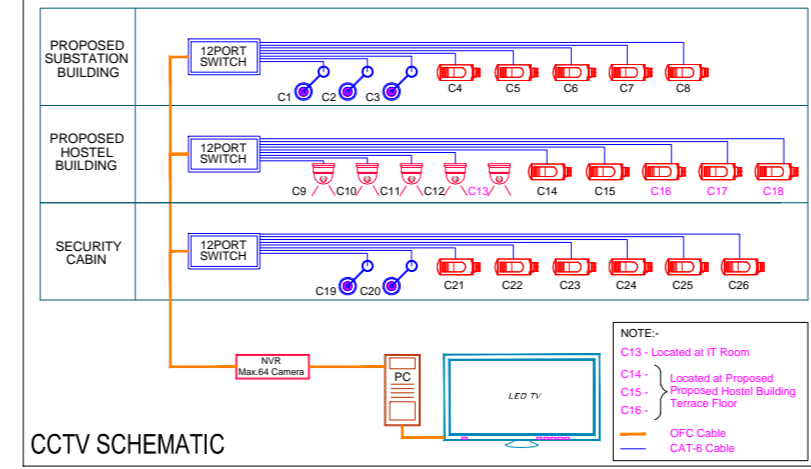

**GENERAL NOTES :**  
 1. ALL DIMENSIONS ARE IN MILLIMETRES AND ARE UNFINISHED DIMENSIONS UNLESS OTHERWISE SPECIFIED.  
 2. ALL LEVELS ARE IN METRES AND ARE UNFINISHED LEVELS UNLESS OTHERWISE SPECIFIED.  
 3. DO NOT SCALE DRAWINGS. ONLY WRITTEN DIMENSIONS SHALL BE FOLLOWED, ANY DISCREPANCIES NOTED SHALL BE BROUGHT TO THE NOTICE OF THE ARCHITECT PRIOR TO EXECUTION.

LEGEND:- CCTV EQUIPMENT

SYMBOL	DESCRIPTION	QTY
	INDOOR DOME IP CAMERA	05 Nos
	OUTDOOR PTZ CAMERA	05 Nos
	OUTDOOR FIXED BOX TYPE CAMERA	16 Nos
	12PORT NETWORK SWITCH	03 Nos

NOTE:-  
 1. CCTV MONITORING STATION SHALL BE LOCATED AT SECURITY CABIN  
 2. ALL THE CAMERA SIGNAL AND POWER CABLE FROM SECURITY CABIN

LEGEND:- CABLES AND CONDUITS

SYMBOL	DESCRIPTION
	110 MM DIA 6KG/CM2 PVC PIPE IN EXCAVATED GROUND
	200MM DIA HUMM PIPE
	MANHOLE CHAMBER

NOTE:-  
 1. ALL THE CAMERAS SIGNAL AND POWER CABLE FROM SECURITY CABIN

REV.	DESCRIPTION	DATE	BY	CHD.
S3	REVISED AS PER MOM DATED ON 22.08.16	23.03.16	VJAY	CV
S2	CABLE ROUTING ADDED	03.03.16	VJAY	CV
S1	ISSUED FOR APPROVAL	30.10.15	VJAY	CV

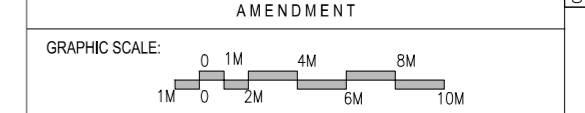

CLIENT:  
**INDIAN INSTITUTE OF TROPICAL METEOROLOGY (IITM) PUNE**

PROJECT:  
**PROPOSED CONSTRUCTION OF STUDENTS HOSTEL BUILDING**

DRAWING TITLE:  
**EXTERNAL CCTV LOCATION LAYOUT**

SCALE : 1 : 250  
 DATE : 30.10.15  
 DRAWN : K.VIJAYASEKAR  
 CHKD : C.VENKATESU

DRAWING NO:  
**IITM-P-HST-IBMS01-01-04-199200**

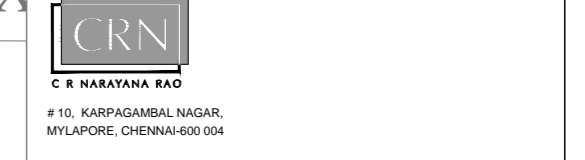

B.Tech. (Hons.), M.S., (III), Ph.D., M.Am.Soc. C.E., F.I.E., F.I.V.,  
 Chartered Engineer - Registered Architect.

IITM- HOSTEL BLOCK-SITE PLAN

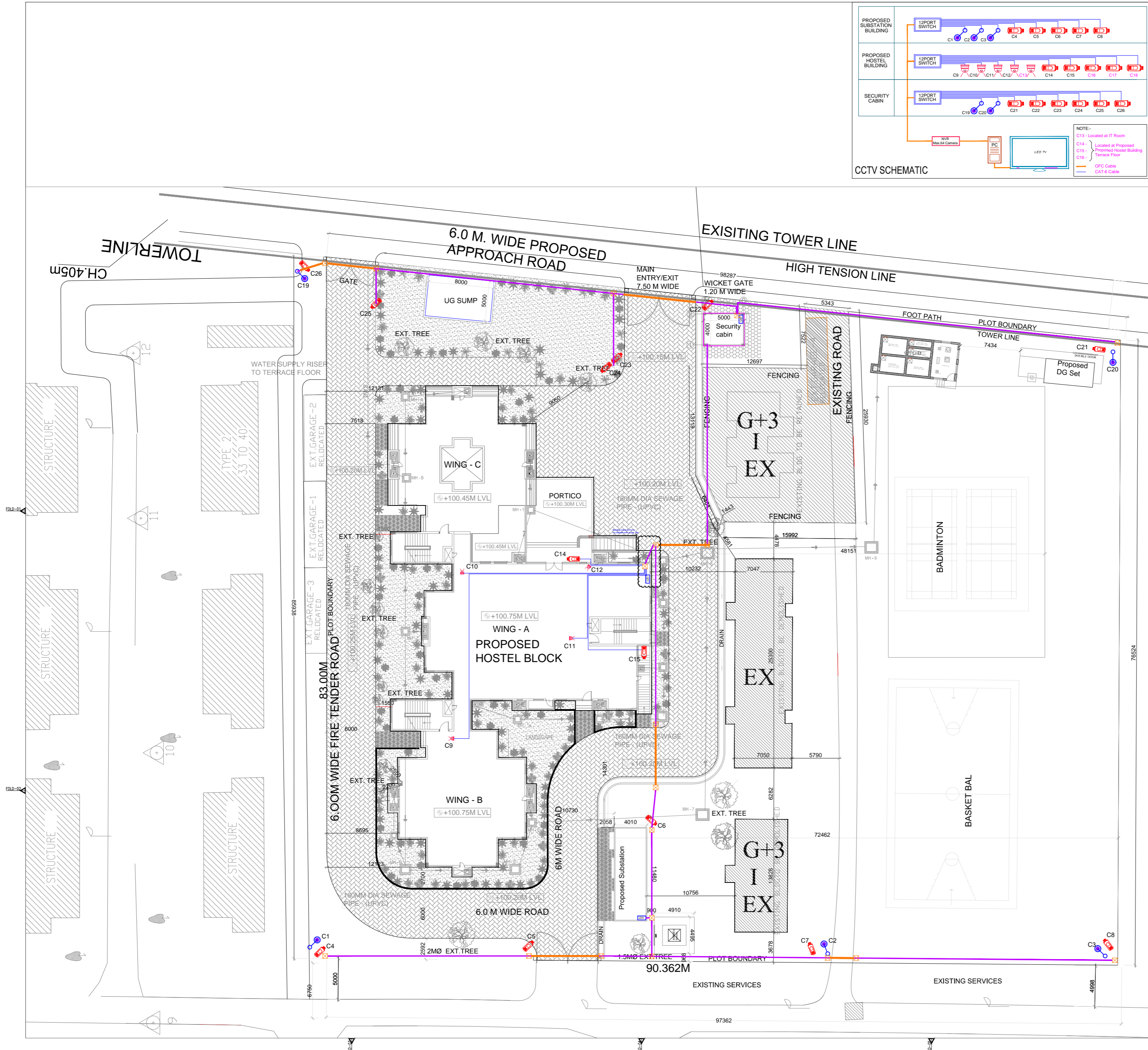

Construction work shall be executed only as per the latest revision drawing. Once a revision drawing is issued, the validity of the previous revision drawing stands cancelled and as such construction shall not be carried out as per superseded revisions. The Contractor is expected to ensure that the drawings are up-to-date and that all necessary approvals are obtained from time to time. The Contractor shall be responsible for ensuring that the drawings are up-to-date and that all necessary approvals are obtained from time to time. The Contractor shall be responsible for ensuring that the drawings are up-to-date and that all necessary approvals are obtained from time to time. The Contractor shall be responsible for ensuring that the drawings are up-to-date and that all necessary approvals are obtained from time to time.